

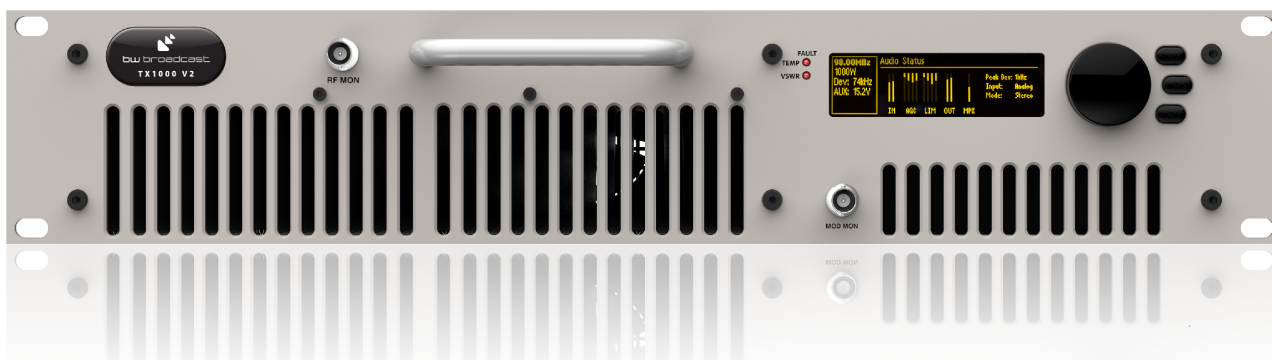

V2 FM TRANSMITTERS



TECHNICAL MANUAL

Document rev 3.2

The software in the transmitter is upgradeable. This manual may refer to an older software version. Note that previous versions of software may not have all of the features described in the manual. To check the latest software go to www.bwbroadcast.com/downloads

No part of this manual may be re-produced in any form without prior written permission from BW Broadcast. The information and specifications contained in this document is subject to change at any time without notice.

©2014 BW Broadcast

www.bwbroadcast.com

VOLTAGE WARNING
TX1000 V2 - TX2500 V2
Do not connect
to 110V
See page 11

Contents

I	Introduction	8
1	The TX-V2	9
2	Warranty	10
3	Safety	12
4	Front and Rear Panels	16
4.1	1U (TX5, TX30, TX50)	16
4.2	2U (TX300, TX600)	17
4.3	2U (TX1000, TX1500)	18
4.4	3U (TX2500)	19
5	User Interface	20
5.1	Input Interface	20
5.1.1	Navigating the menu	20
5.1.2	Editing a parameter	20
5.1.3	Text fields	20
5.2	Display	21
5.2.1	Status Box	21
5.2.2	Menu Box	22
5.2.3	Meters	23

II	Initial Setup and connections	24
6	Installation	25
6.1	Quick Start	25
6.2	Examples of Use	26
6.2.1	Transmitter with an external RDS encoder and internal audio processing	26
6.2.2	Transmitter with an external audio processor	27
6.2.3	Transmitter with an external audio processor and RDS (In Line Connection)	28
6.2.4	Transmitter with an external audio processor and RDS (Side Chain Connection)	29
III	System Configuration	31
7	Operation Guide	32
7.1	RF Settings	32
7.1.1	Basic Setup	32
7.1.2	Power Scheduler	32
7.2	Audio Settings	33
7.3	Triggers	33
7.4	Alarms	34
7.5	System	35
7.5.1	Real Time Clock	35
7.5.2	Unit Information	35
7.5.3	Screen Saver	36
7.5.4	Users	36
7.5.5	Ethernet	36
7.5.6	E-Mail	37
7.5.7	HTTP	38
7.5.8	Telnet	38

7.5.9	RS232	39
7.5.10	Log	39
7.5.11	Diagnostics	41
7.5.12	About	41
7.5.13	Reboot	41
7.5.14	Factory Reset	41
7.6	Web Remote	41
7.6.1	Autentication	41
7.6.2	Web Remote Interface	42
7.7	Text Based Access (Telnet or Serial RS232)	44
7.7.1	Commands	44
7.8	Web API	45
7.8.1	Authentication	46
7.8.2	Setting A Parameter	46
7.8.3	Reading Parameters	47
7.8.4	Reading Meters	48
7.8.5	Reading log files	48
7.9	Parameters	49
7.9.1	RF Settings	49
7.9.2	Audio Settings	51
7.9.3	Triggers	52
7.9.4	Alarms	53
7.9.5	System	54
8	Parameter Guide	62
8.1	RF Settings	62
8.1.1	Frequency	62
8.1.2	Power	62
8.1.3	MPX Source	62

8.1.4	FSK (for translators in the USA)	63
8.1.5	RF Mute on Silence	63
8.1.6	RF Mute (Manual)	63
8.1.7	Power Scheduler	63
8.2	Audio Settings	64
8.2.1	MPX Source	64
8.2.2	Audio Input	64
8.2.3	Processing Preset	65
8.2.4	Pre-emphasis	65
8.3	Triggers	65
8.3.1	Enable	65
8.3.2	Action	66
8.3.3	Send e-mail	66
8.3.4	(ON) Message	66
8.4	Alarms	67
8.4.1	Type	67
8.5	System	70
8.5.1	Date	70
8.5.2	Time	71
8.5.3	Uptime	71
8.5.4	Location	71
8.5.5	Contact	71
8.5.6	Screen Saver	71
8.5.7	Screen Lock	71
8.5.8	Screen Lock Code	71
8.5.9	Users	71
8.5.10	Ethernet	72
8.5.11	E-Mail	73

8.5.12 HTTP	74
8.5.13 Telnet	74
8.5.14 RS232	75
8.5.15 Log	75
8.5.16 Diagnostics	76
8.5.17 About	76
8.5.18 Reboot	77
8.5.19 Factory Reset	77
IV Troubleshooting	78
9 V2 FM Transmitter Troubleshooting Guide	79
V Technical Specifications	81
10 Technical Specifications	82
10.1 Common Specifications	82
10.1.1 RF	82
10.1.2 Audio and MPX I/O	82
10.1.3 Stereo	82
10.1.4 Limiter	83
10.1.5 Other	83
10.1.6 Temperature Protection	83
10.1.7 VSWR Protection	83
10.2 Model-Specific Specifications	84
10.2.1 TX5 V2	84
10.2.2 TX30 V2	84
10.2.3 TX50 V2	85
10.2.4 TX300 V2	86

10.2.5 TX600 V2	86
10.2.6 TX1000 V2	87
10.2.7 TX1500 V2	87
10.2.8 TX2500 V2	88

Part I

Introduction

The TX-V2

The BW Broadcast TX-V2 is the latest development in a high specification range of FM transmitters over 15 years in the making.

Its broadband "no-tune" design allows 87.5 - 108MHz operation without requiring tuning or calibration. The inclusion of four-band DSPX audio processing means stations without a dedicated processor sound great, right out of the box. Those who already have external processing benefit from BW Broadcast's unique dual-loop virtual VFO exciter and field proven ultra-low distortion modulator integrated into a great performing, highly stable FM transmission system.

Features such as slide-in power supplies, and unique solder-free Gold-Clamp transistors (on most models) make in-field maintenance simple.

A high resolution OLED screen displays RF, audio and system parameters. The control wheel and three front panel buttons allow easy navigation of the menus. Help tips for every parameter make setup simple.

Every TX-V2 Transmitter features a LAN connection for Ethernet local or remote control. The LAN connection also supports SNMP, telnet, and email alerts via either SMTP or BW Broadcast's mail server. Where a LAN connection is not available, the RS232 connection can be used.

Intelligent alarms and email alerts ensure busy engineers can manage their stations with minimal intervention. A real time clock and comprehensive logging is available for those who like to see more detailed status. Also present are 4 rear panel opto-isolated triggers that allow external equipment to control the transmitter.

It is advised that this manual is read to learn all of the advanced features of the TX-V2 Transmitter.

Warranty

Please ensure the Warranty Registration process is completed upon receipt of this product. To do so go to www.bwbroadcast.com/warranty with your product's serial number to hand. BW Broadcast warrants the mechanical and electronic components of this product to be free of defects in material and workmanship for a period of two (2) years* from the original date of purchase, in accordance with the warranty regulations described below. If the product shows any defects within the specified warranty period that are not due to normal wear and tear and/or improper handling by the user, BW Broadcast shall, at its sole discretion, either repair or replace the product. If the warranty claim proves to be justified, the product will be returned to the user freight prepaid. Warranty claims other than those indicated above are expressly excluded.

Return authorisation number: To obtain warranty service, the buyer (or his authorized dealer) must contact BW Broadcast during normal business hours BEFORE returning the product. All inquiries must be accompanied by a description of the problem. BW Broadcast will then issue a return authorization number. Subsequently, the product must be returned in its original shipping carton, together with the return authorization number to the address indicated by BW Broadcast. Shipments without freight prepaid will not be accepted.

Warranty regulations: Any product deemed eligible for repair or replacement by BW Broadcast under the terms of this warranty will be repaired or replaced within 30 days of receipt of the product at BW Broadcast. If the product needs to be modified or adapted in order to comply with applicable technical or safety standards on a national or local level, in any country which is not the country for which the product was originally developed and manufactured, this modification/- adaptation shall not be considered a defect in materials or workmanship. The warranty does not cover any such modification/adaptation, irrespective of whether it was carried out properly or not. Under the terms of this warranty, BW Broadcast shall not be held responsible for any cost resulting from such a modification/adaptation. Free inspections and maintenance/repair work are expressly excluded from this warranty, in particular, if caused by improper handling of the product by the user. This also applies to defects caused by normal wear and tear, in particular, of faders, potentiometers, keys/buttons and similar parts. Damages/defects caused by the following conditions are not covered by this warranty: Misuse, neglect or failure to operate the unit in compliance with the instructions given in BW Broadcast user or service manuals. Connection or operation of the unit in any way that does not comply with the technical or safety regulations applicable in the country where the product is used. Damages/defects caused by force majeure or any other condition that is beyond the control of BW Broadcast. Any repair or opening of the unit carried out by unauthorized personnel (user included) will void the warranty. If an inspection of the product by BW Broadcast shows that the defect in question is not covered by the warranty, the inspection costs are payable by the customer. Products which do not meet the terms of this warranty will be repaired exclusively at the buyer's expense. BW Broadcast will inform the buyer of any such circumstance.

Warranty transferability: This warranty is extended exclusively to the original buyer (customer of retail dealer) and is not transferable to anyone who may subsequently purchase this product. No other person (retail dealer, etc.) shall be entitled to give any warranty promise on behalf of BW Broadcast.

Claims for damages: Failure of BW Broadcast to provide proper warranty service shall not entitle the buyer to claim (consequential) damages. In no event shall the liability of BW Broadcast exceed the invoiced value of the product.

Other warranty rights and national law: This warranty does not exclude or limit the buyer's statutory rights provided by national law, in particular, any such rights against the seller that arise from a legally effective purchase contract. The warranty regulations mentioned herein are applicable unless they constitute an infringement of national warranty law.

*Warranty period can be extended for an additional cost at point of purchase

Safety

MAINS VOLTAGE: TX5 V2 - TX600 V2 operate from an AC power source between 110 and 240 V.

TX1000 V2 - TX2500 V2 operate from a power source between 220 and 240 V. **WARNING:** To avoid damage DO NOT CONNECT TO 110V.

These power supplies use a C19 plug. The wiring format is:

Ground - GREEN/YELLOW

Neutral - BLUE

Live - BROWN

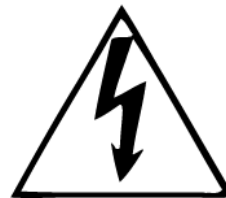

SWITCHED MODE POWER SUPPLY HAZARD Please note that the power supply units in this equipment is of the switched mode variety and have lethal voltages present internally. The switched mode supplies are universal input fully approved type. They are non serviceable modules and should be fully replaced should they fail.

FUSES Only use fuses with the specified voltage and current ratings as stated on the back panel. Failure to do so may increase the risk of equipment failure, shock and fire hazard.

R.F. The N type R.F. power output socket contains R.F. voltages which may burn or present a shock. Please make sure that the equipment is connected to an adequately rated load or antenna system while in operation.

TOXIC HAZARD This equipment includes R.F. components that may contain Beryllium oxide which is a highly toxic substance that could be hazardous to health if inhaled or ingested. Care should be taken when replacing or discarding such devices. Seek expert advice from the manufacturer should you physically damage a device that contains Berillyium Oxide. The main R.F. output power transistor contains Beryllium oxide.

OTHER SAFETY CONSIDERATIONS Do not operate this equipment in the presence of flammable gases, fumes or liquids Do not expose this equipment to rain or water.

CE CONFORMANCE This device complies with the requirements of the 1995/5/EC Radio and Telecommunications Terminal Equipment (R&TTE). The equipment will meet or exceed the following standards: EN 60215:1996 (Safety Requirements for Radio Transmitting Equipment), EN 301 489-11 (ERM/EMC for Radio Equipment, Part 11 Specific Conditions for FM Transmitters), EN 302 018-2 ERM (Transmitting Equipment for FM Radio Broadcasting service)



The operating frequencies of this transmitter may not be harmonised in the intended countries of use. The user must obtain a license before using the product in the intended country of use. Ensure respective country licensing requirements are complied with. Limitations of use can apply in respect of operating frequency, transmitter power and/or channel spacing.

WEEE COMPLIANCE BW Broadcast Ltd is registered with Northern Compliance PCS number WEE/P3438PR/ SCH and has been issued with WEE/FA0268RX as its unique producer ID by the appropriate environment agency. BW Broadcast Ltd full comply with it explicit responsibilities, subject to WEEE Collections Policy outlined in their General Terms and conditions of Sale, when it sells Electrical and Electronic Equipment (EEE) to B2B customers in the UK and EU.



This appliance has been designed and manufactured with high quality materials and components that can be recycled and reused. Electronic appliances are liable to contain parts that are necessary in order for the system to work properly but which can become a health and environmental hazard if they are not handled and disposed of in the proper way. Consequently, please do not throw your inoperative appliance with the household waste. Having purchased this appliance it is your responsibility to dispose of this equipment appropriately.

CAUTION: To reduce the risk of electrical shock, do not remove the cover. No user serviceable parts inside. refer servicing to qualified personnel.

WARNING: To reduce the risk of fire or electrical shock, do not expose this appliance to rain or moisture.

DETAILED SAFETY INSTRUCTIONS:

All the safety and operation instructions should be read before the appliance is operated.

Retain Instructions: The safety and operating instructions should be retained for future reference.

Heed Warnings: All warnings on the appliance and in the operating instructions should be adhered to.

Follow instructions: All operation and user instructions should be followed.

Water and Moisture: The appliance should not be used near water (e.g. near a bathtub, washbowl, kitchen sink, laundry tub, in a wet basement, or near a swimming pool etc.). The appliance should not be exposed to dripping or splashing and objects filled with liquids should not be placed on the appliance.

Ventilation: The appliance should be situated so that its location or position does not interfere with its proper ventilation. For example, the appliance should not be situated on a bed, sofa rug, or similar surface that may block the ventilation openings, or placed in a built-in installation, such as a bookcase or cabinet that may impede the flow of air through the ventilation openings.

Heat: The appliance should be situated away from heat sources such as radiators, heat registers, stoves, or other appliance (including amplifiers) that produce heat.

Power Source: The appliance should be connected to a power supply only of the type described in the operating instructions or as marked on the appliance.

Grounding or Polarization: Precautions should be taken so that the grounding or polarization means of an appliance is not defeated.

Power-Cord Protection: Power supply cords should be routed so that they are not likely to be walked on or pinched by items placed upon or against them, paying particular attention to cords and plugs, convenience receptacles and the point where they exit from the appliance.

Cleaning: The appliance should be cleaned only as recommended by the manufacturer.

Non-use Periods: The power cord of the appliance should be unplugged from the outlet when left unused for a long period of time.

Object and Liquid Entry: Care should be taken so that objects do not fall and liquids are not spilled into the enclosure through openings.

Damage Requiring Service: The appliance should be serviced by qualified service personnel when:

- The power supply cord or the plug has been damaged; or
- Objects have fallen, or liquid has been spilled into the appliance; or
- The appliance has been exposed to rain; or
- The appliance does not appear to operate normally or exhibits a marked change in performance; or
- The appliance has been dropped, or the enclosure damaged.

Servicing: The user should not attempt to service the appliance beyond that is described in the Operating Instructions. All other servicing should be referred to qualified service personnel.

Front and Rear Panels

4

4.1 1U (TX5, TX30, TX50)

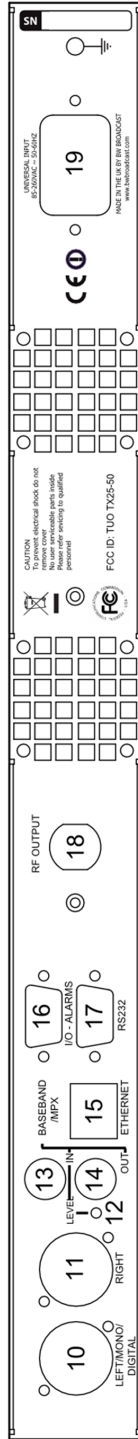
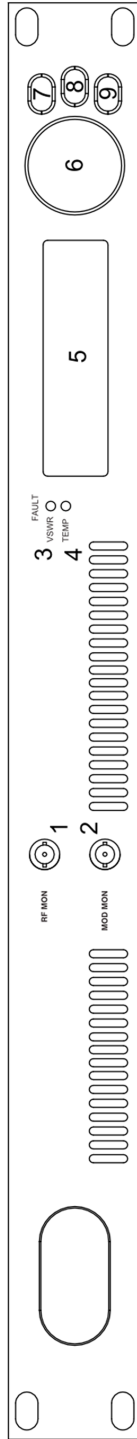

- Front Panel**
- 1 - RF Monitor
 - 2 - Modulation Monitor
 - 3 - VSWR Indicator LED
 - 4 - Temp Indicator LED
 - 5 - OLED Screen
 - 6 - Control Wheel
 - 7 - Back Button
 - 8 - Help Button
 - 9 - Menu Button

- Rear Panel**
- 10 - Analog Left/Digital Audio XLR Input
 - 11 - Analog Right Audio XLR Input
 - 12 - MPX Input Level Control
 - 13 - MPX Input BNC
 - 14 - MPX Output BNC
 - 15 - Ethernet Jack
 - 16 - Alarms/Trigger Port
 - 17 - RS232/Serial Port
 - 18 - RF Out Type N Connector
 - 19 - IEC Mains Power Connector

-
- I/O - Alarms**
- 1 Ground
 - 2 RF Mute
 - 3 Alarm C
 - 4 Trigger 2
 - 5 Trigger 4
 - 6 Alarm A
 - 7 Alarm B
 - 8 Trigger 1
 - 9 Trigger 3

-
- XLR Audio Connectors**
- 1 Ground
 - 2 Hot (+)
 - 3 Cold (-)

4.2 2U (TX300, TX600)

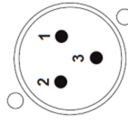
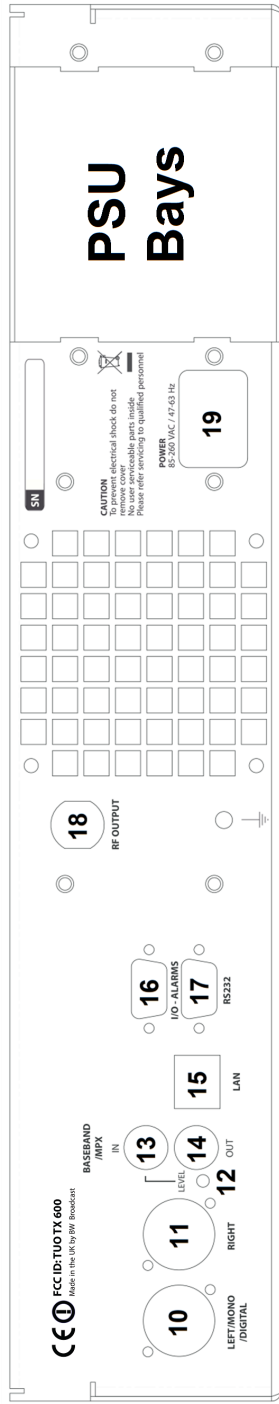
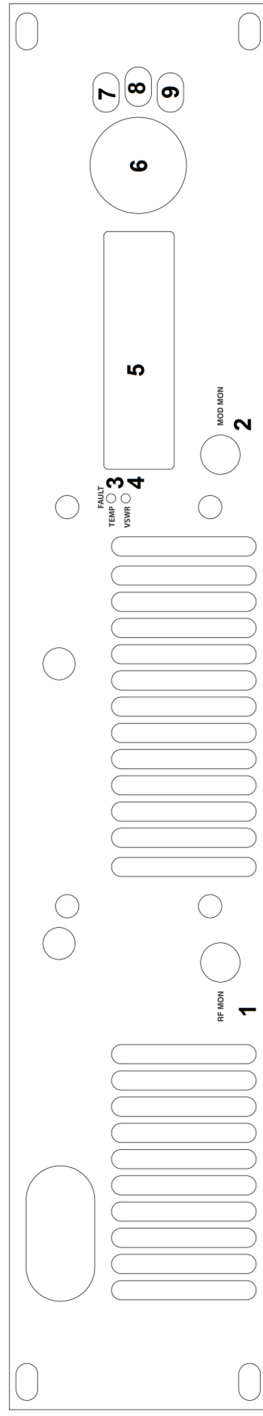

- XLR Audio Connectors**
- 1 Ground
 - 2 Hot (+)
 - 3 Cold (-)

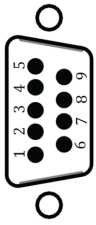

- I/O - Alarms**
- 1 Ground
 - 2 RF Mute
 - 3 Alarm C
 - 4 Trigger 2
 - 5 Trigger 4
 - 6 Alarm A
 - 7 Alarm B
 - 8 Trigger 1
 - 9 Trigger 3

- Rear Panel**
- 10 - Analog Left/Digital Audio XLR Input
 - 11 - Analog Right Audio XLR Input
 - 12 - MPX Input Level Control
 - 13 - MPX Input BNC
 - 14 - MPX Output BNC
 - 15 - Ethernet Jack
 - 16 - Alarms/Trigger Port
 - 17 - RS232/Serial Port
 - 18 - RF Out Connector
 - 19 - IEC Mains Power Connector

- Front Panel**
- 1 - RF Monitor
 - 2 - Modulation Monitor
 - 3 - VSWR Indicator LED
 - 4 - Temp Indicator LED
 - 5 - OLED Screen
 - 6 - Control Wheel
 - 7 - Back Button
 - 8 - Help Button
 - 9 - Menu Button

4.3 2U (TX1000, TX1500)

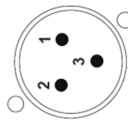
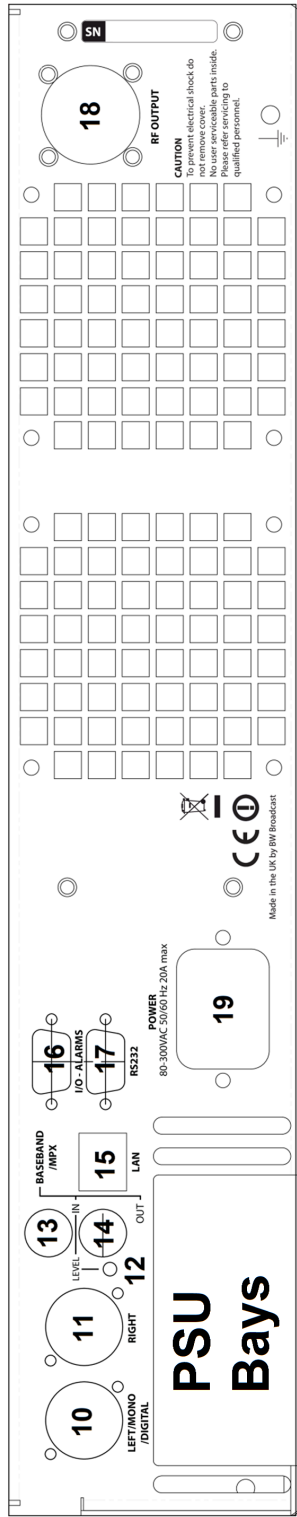
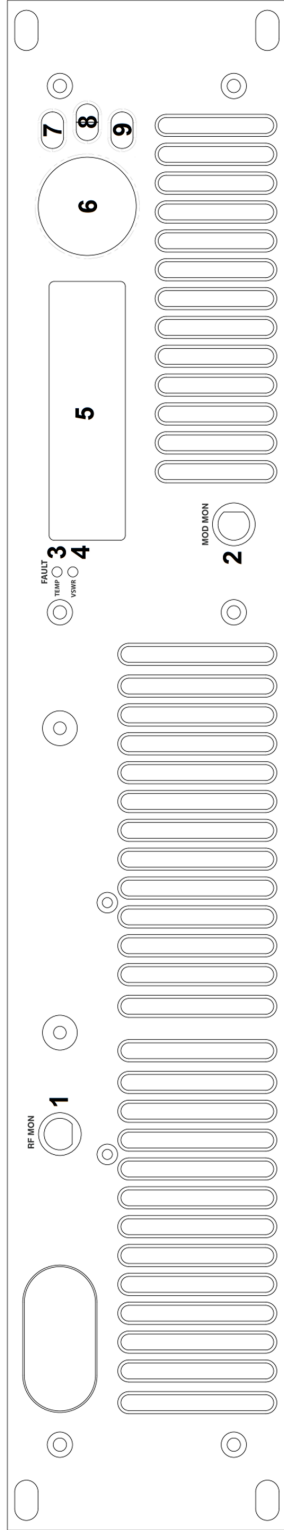

- XLR Audio Connectors**
- 1 Ground
 - 2 Hot (+)
 - 3 Cold (-)

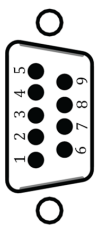

- I/O - Alarms**
- 1 Ground
 - 2 RF Mute
 - 3 Alarm C
 - 4 Trigger 2
 - 5 Trigger 4
 - 6 Alarm A
 - 7 Alarm B
 - 8 Trigger 1
 - 9 Trigger 3

- Rear Panel**
- 10 - Analog Left/Digital Audio XLR Input
 - 11 - Analog Right Audio XLR Input
 - 12 - MPX Input Level Control
 - 13 - MPX Input BNC
 - 14 - MPX Output BNC
 - 15 - Ethernet Jack
 - 16 - Alarms/Trigger Port
 - 17 - RS232/Serial Port
 - 18 - RF Out Connector
 - 19 - IEC Mains Power Connector

- Front Panel**
- 1 - RF Monitor
 - 2 - Modulation Monitor
 - 3 - VSWR Indicator LED
 - 4 - Temp Indicator LED
 - 5 - OLED Screen
 - 6 - Control Wheel
 - 7 - Back Button
 - 8 - Help Button
 - 9 - Menu Button

4.4 3U (TX2500)

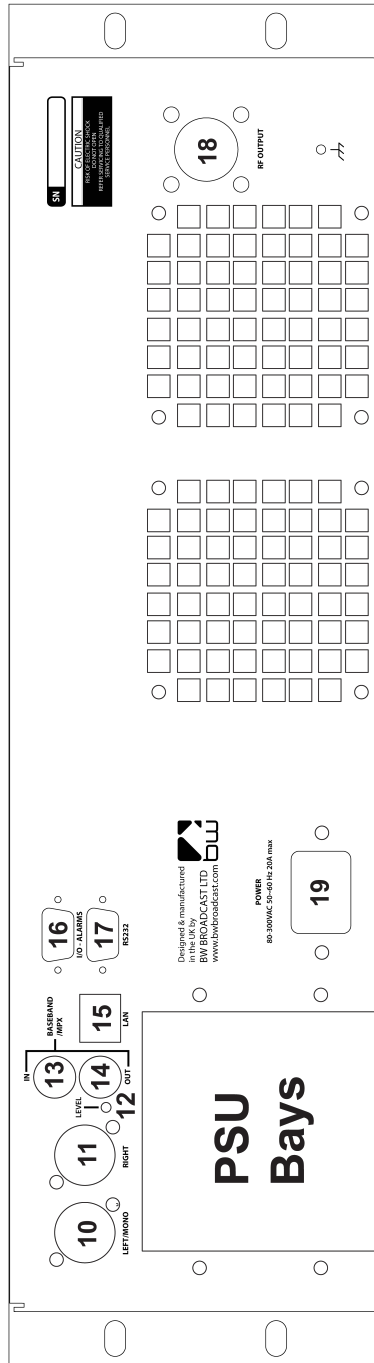
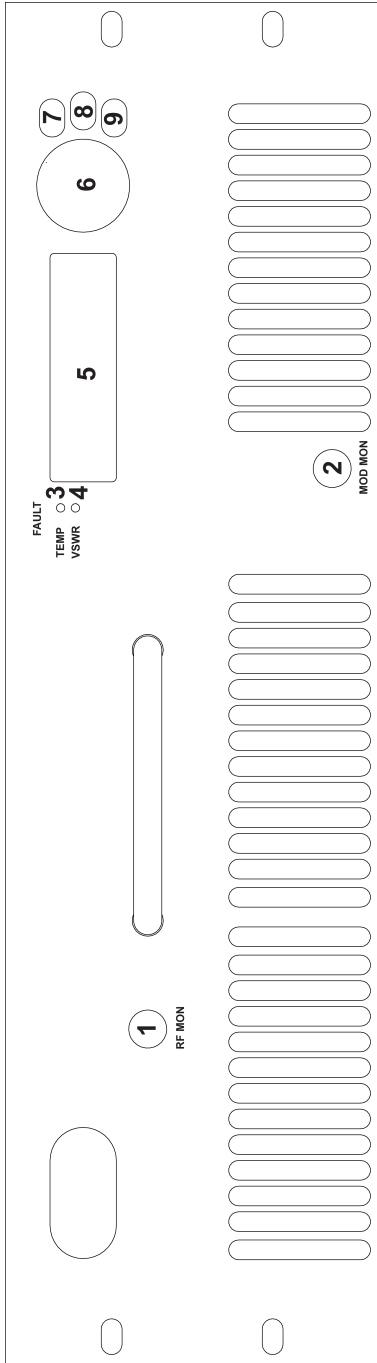

Front Panel

- 1 - RF Monitor
- 2 - Modulation Monitor
- 3 - VSWR Indicator LED
- 4 - Temp Indicator LED
- 5 - OLED Screen
- 6 - Control Wheel
- 7 - Back Button
- 8 - Help Button
- 9 - Menu Button

Rear Panel

- 10 - Analog Left /digital Audio XLR Input
- 11 - Analog Right Audio XLR Input
- 12 - MPX Input Level Control
- 13 - MPX Input BNC
- 14 MPX Output BNC
- 15 - Ethernet Jack
- 16 - Alarms/Trigger Port
- 17 - RS232/ Serial Port
- 18 - RF Out Connector
- 19 - IEC Mains Power Connector

I/O Alarms

- 1 Ground
- 2 RF Mute
- 3 Alarm C
- 4 Trigger 2
- 5 Trigger 4
- 6 Alarm A
- 7 Alarm B
- 8 Trigger 1
- 9 Trigger 3

XLR Audio Connectors

- 1 Hot
- 2 Hot (+)
- 3 Cold (-)

User Interface

5.1 Input Interface

The TX-V2 has an intuitive interface based around a pushable scroll wheel and three buttons.

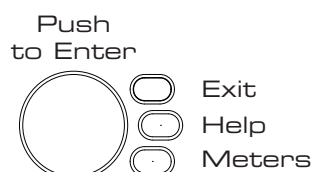

5.1.1 Navigating the menu

The menu is navigated by rotating the scroll wheel, pushing it in to open a submenu. Within in a submenu, pressing exit will return to the parent menu.

5.1.2 Editing a parameter

To edit a parameter, first find it in the menu, highlight it and press enter. For most parameters this will result in the parameter being highlighted (black text on a yellow background). The value of the parameter can now be modified using touch sensitive wheel. When the correct value is selected, press exit to take you back to menu-navigation mode.

Some parameters require a bit more space to edit (e.g. text fields). For these parameters, a dialog box will pop up allowing more space to edit.

5.1.3 Text fields

When editing a text field, a dialog box will appear allowing modification of the full text. Pressing enter will toggle between two modes:

- Scrolling through the text: the selected character will have a yellow rectangle around it.
- Modifying the current character: the character will be black on a yellow background. When modifying a letter, one of the soft-keys will allow selection between the four character sets: lowercase letters, uppercase letters, numbers and symbols.

5.2 Display

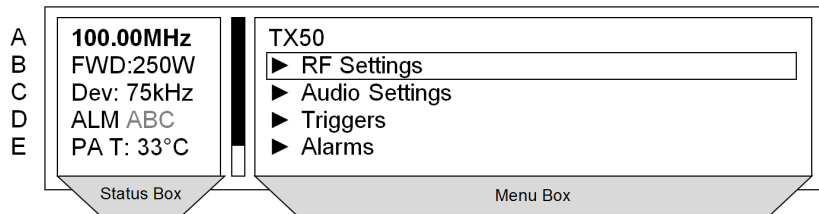

5.2.1 Status Box

This section of the display gives real time information about the status of the transmitter

A Frequency

The target frequency of the transmitter. When the transmitter is tuning to frequency on start-up (out of lock), this will flash between full and half brightness, When the transmitter is locked (has reached frequency), it will remain at full brightness.

B Power

The actual power of the transmitter. After the transmitter has locked on frequency, the power will ramp up to the set level. During this time the power display will flash between full and half brightness. When the power level has settled, it will remain at full brightness. If RF Mute is set either manually or automatically, this section displays "RF Mute". If the reverse power is greater than 10 per cent of the forward power, this section will alternate between "FWD" and "REV" to display both readings.

C Deviation

Shows the current peak FM deviation of the transmitter. If the deviation falls below 30kHz for 30 seconds the deviation display will flash to indicate abnormal modulation.

D Alarms

Indicates alarms which are set or triggered. The letters A-C indicate when an alarm is enabled and when an alarm is triggered. Each alarm has two states:

A - Greyed out - Alarm is enabled but not triggered.

A → A → **A** - Alarm is flashing - Alarm has been triggered.

For example:

Not shown - No alarms set

ALM A - Only Alarm A is enabled.

ALM ABC - All alarms are enabled.

ALM ABC - Alarm A and alarm C are triggered, Alarm B is enabled.

ALM ABC - All alarms are triggered.

An indication the alarms have been triggered will also be shown on the screensaver.

E **PA temperature/Power supply voltages/Reverse power**

Displays the temperature of the Power Amplifier, the voltages of the Power amplifier power supply and of the auxiliary power supply and the reverse power:

- PA T: 30°C - Power amplifier temperature.
- PA V: 30.6V - Voltage of power amplifier power supply.
- AUX: 15.2V - Voltage of auxiliary power supply for the control system and exciter of the transmitter.
- REV: 0.0W - Reverse power.

If FSK is enabled, this section will read FSK ACTIVE while the transmitter is keying as shown below. Do not expect to see this symbol often as it will only display for around 15 seconds every hour.

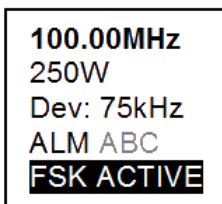

100.00MHz
250W
Dev: 75kHz
ALM ABC
FSK ACTIVE

5.2.2 Menu Box

This is the main section of the user interface. Navigate by rotating the control wheel and select a menu option by pushing it in. The top button is the back button to move one level up in the menu structure. The middle button is the help button and will give a brief description of the function of each menu item. The arrow in the menu (>) indicates the current item is a sub menu. A map of the entire menu system along with each item's help description is given in the appendix at the end of this document.

5.2.3 Meters

V2 Transmitters offer extensive metering with just a few clicks of the bottom menu button. Click the menu button to cycle through each of the 3 meters screens: RF Status, Audio Status and Config. Status. To leave the meters screen press the exit button.

RF Status			
RF Mute:	No	Exciter Locked:	Yes
Set Power:	25W	PA Voltage:	18.9V
FWD Power:	24W	AUX Voltage:	15.1V
REV Power:	0W	PA Temp (C):	38

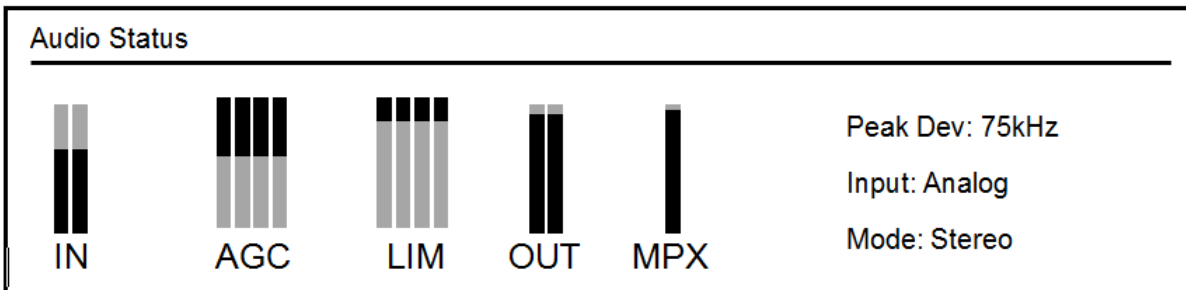

Config Status			
2013-05-19	10:05:35	Serial #:	8723
UP:	30 days,	Product Ver:	1.1
	10:05:37	FW Ver:	1.2.4
IP: 192.168.0.111		HW Ver:	1.0
HTTP Port: 80		AIO FW Ver:	1.0

Part II

Initial Setup and connections

Installation

6.1 Quick Start

N.B. Never power on an FM transmitter without a suitable antenna or dummy load connected. The V2 Transmitter's protection circuitry will prevent any internal damage, but it is not advisable to run an FM transmitter without a load connected.

Setting up a V2 Transmitter couldn't be any easier. First connect either analogue audio to the left and right back panel connectors (10 and 11), digital audio AES/EBU into the left hand connector (10) or feed the MPX input (13) from an audio processor. Connect the RF output (18) to a 50Ohm antenna of the correct power handling capability. Connect the required remote control / monitoring ports (Ethernet, RS232, Alarms/Triggers Port).

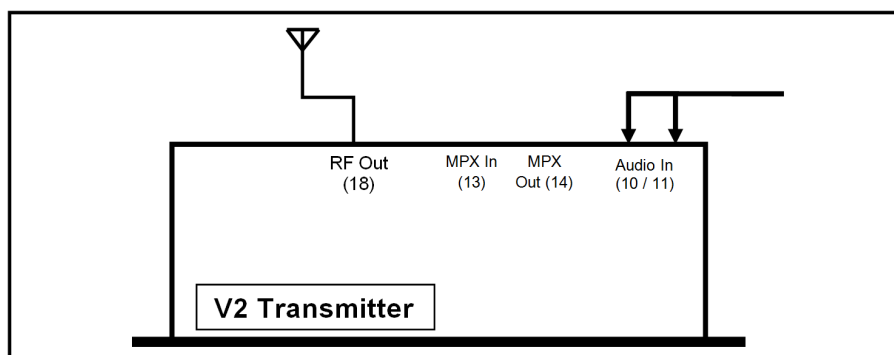

The transmitter's frequency and power are both set from the RF Settings menu:

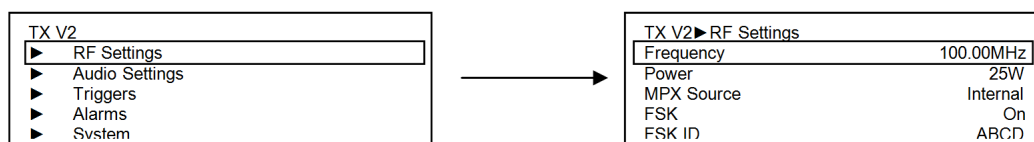

Input selection, pre-emphasis, processing and the stereo parameters are set in the audio settings menu:

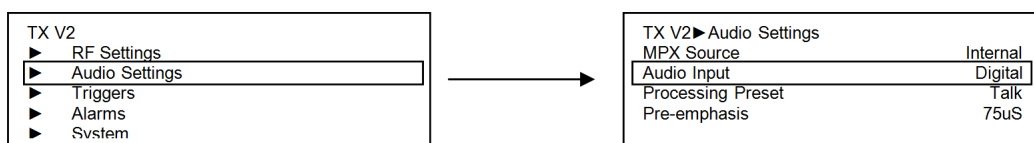

Input Selects analog or digital input to the transmitter's built in stereo encoder/audio processor. For analog, connect to left and right XLR Inputs. For digital, connect an AES/EBU connection to the left hand XLR input.

Pre emphasis Sets pre emphasis to off, 50µS (Europe/Japan) or 75µS (Americas).

Processing Preset Selects the processing preset on the integrated 4-band DSPX audio processor.

Encoder Selects the stereo generator mode, from either: Stereo, Mono L+R, Mono L, Mono R and Swap L + R.

MPX Source Selects if the MPX source for the exciter is internal or external. If using the V2 transmitter with no external equipment (RDS, audio processor etc) then set to internal. If using any external equipment set to external. When set to internal, the MPX In and MPX Out connectors are internally connected, which routes the internal stereo generator directly to the exciter. When set to external, the internal the internal stereo generator and audio processor are still functioning, but the MPX in and MPX out connections are not internally connected, allowing MPX signals to be routed to and/or from external equipment.

6.2 Examples of Use

6.2.1 Transmitter with an external RDS encoder and internal audio processing

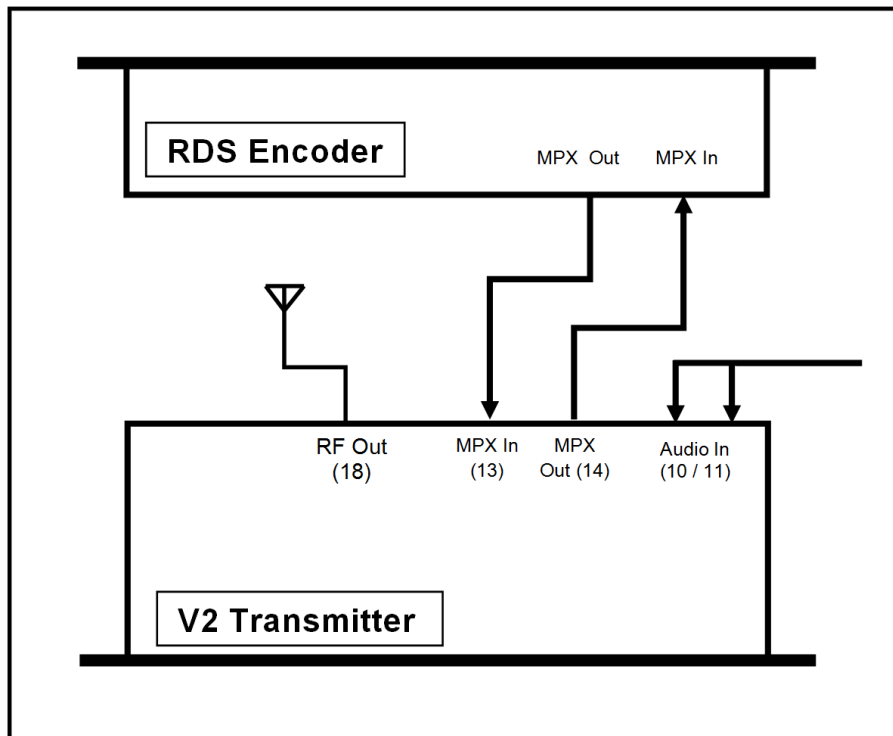

1. Place the transmitter in a well ventilated space.
2. Connect the antenna to the RF output connector on the back of the transmitter.
3. Connect the left and right program audio signals to the XLR input connectors on the back of the transmitter. If using AES/EBU digital, connect this to the left audio input XLR connector.

4. Connect the Baseband/MPX output on the back of the transmitter to the MPX input of the RDS encoder.
5. Connect the MPX output of the RDS encoder to the MPX input on the back of the transmitter.
6. Plug the power cord into the power supply module on the rear panel of the transmitter.
7. Connect the required remote control / monitoring ports (Ethernet, RS232, Alarms/Triggers Port).
8. In the audio settings menu, select the input source (analog/digital) and set MPX source to external.
9. Once the transmitter is operating, set the correct carrier frequency and RF power from the RF settings menu. Check reflected power is OK.
10. Check the documentation that came with your RDS encoder on how to set/check the proper RDS injection level.

6.2.2 Transmitter with an external audio processor

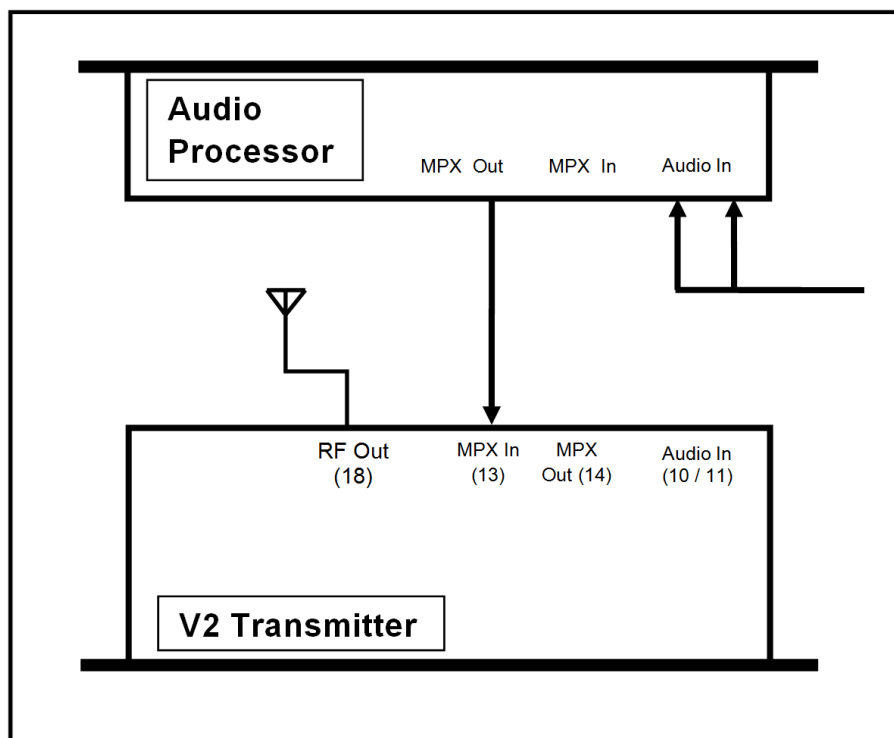

1. Place the transmitter in a well ventilated space.
2. Connect the antenna to the RF output connector on the back of the transmitter.

3. Connect the MPX output of your audio processor (or stereo generator) to the MPX input on the back of the transmitter.
4. Plug the power cord into the power supply module on the rear panel of the transmitter.
5. Connect the required remote control / monitoring ports (Ethernet, RS232, Alarms/Triggers Port).
6. In the RF settings menu, set MPX source to external.
7. Once the transmitter is operating, set the correct carrier frequency and RF power from the RF settings menu. Check reflected power is OK.
8. Check the modulation level - if the modulation level is low, adjust the MPX output level on your audio processor (or stereo generator) and/or the MPX input level on the back of the transmitter. The maximum modulation should not exceed 75kHz.
9. Check the documentation that came with your audio processor on how to set/check the proper pilot injection level.

In this setup, the stereo multiplex is generated by an external stereo generator and is fed directly into the transmitter exciter of the transmitter stage. Note that the transmitter's onboard processing will have no effect on the signal in this configuration.

6.2.3 Transmitter with an external audio processor and RDS (In Line Connection)

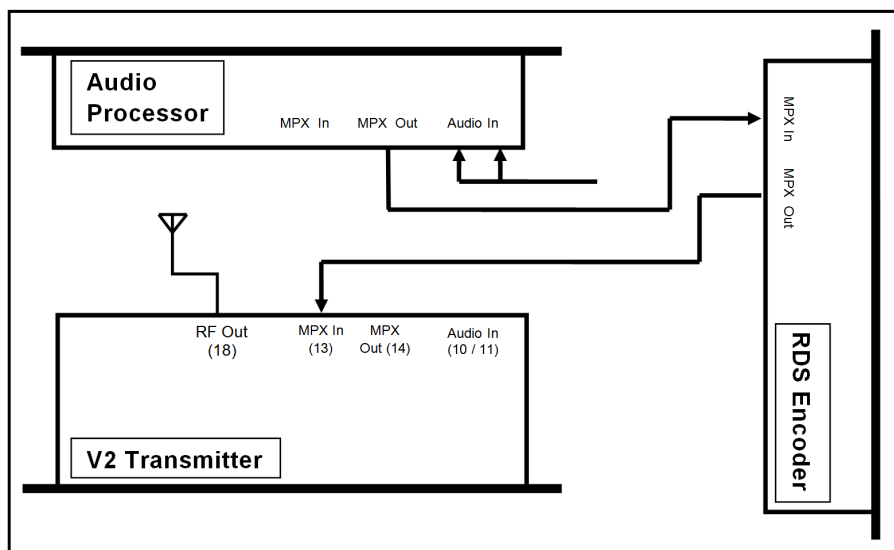

1. Place the transmitter in a well ventilated space.
2. Connect the antenna to the RF output connector on the back of the transmitter.

3. Connect the MPX output of your audio processor (or stereo generator) to the MPX input of your RDS encoder.
4. Connect the MPX output of your RDS encoder to the MPX input on the back of the transmitter.
5. Plug the power cord into the power supply module on the rear panel of the transmitter.
6. Connect the required remote control / monitoring ports (Ethernet, RS232, Alarms/Triggers Port).
7. In the RF settings menu, set MPX source to external.
8. Once the transmitter is operating, set the correct carrier frequency and power from the RF settings menu. Check reflected power is OK.
9. Check the modulation level - if the modulation level is low, adjust the MPX output level on your audio processor (or stereo generator), RDS encoder and/or the MPX input level on the back of the transmitter. The maximum modulation should not exceed 75kHz.
10. Check the documentation that came with your audio processor on how to set/check the proper pilot injection level.
11. Check the documentation that came with your RDS encoder on how to set/check the proper RDS injection level.

In this setup, the stereo multiplex is generated in the audio processor, it is then fed through the RDS encoder where the RDS subcarrier is added. It is then fed directly into the transmitter's exciter. Note that the transmitter's onboard processing will have no effect on the signal in this configuration.

6.2.4 Transmitter with an external audio processor and RDS (Side Chain Connection)

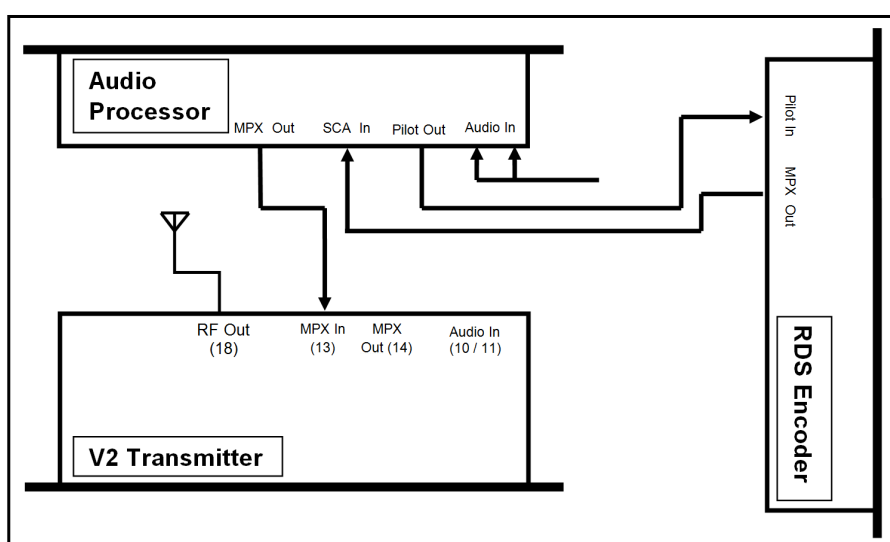

1. Place the transmitter in a well ventilated space
2. Connect the antenna to the RF output connector on the back of the transmitter.
3. Connect the MPX output of your audio processor (or stereo generator) to the MPX input on the back of the transmitter.
4. Connect the Pilot output of your audio processor (or stereo generator) to the pilot/reference input on your RDS encoder.
5. Connect the MPX output of your RDS encoder to the SCA input on your audio processor.
6. Plug the power cord into the power supply module on the rear panel of the transmitter.
7. Connect the required remote control / monitoring ports (Ethernet, RS232, Alarms/Triggers Port).
8. Once the transmitter is operating, set the correct carrier frequency and power from the RF settings menu. Check reflected power is OK.
9. In the RF settings menu, set MPX source to external.
10. Check the modulation level - if the modulation level is low, adjust the MPX output level on your audio processor (or stereo generator) and/or the MPX input level on the back of the transmitter. The maximum modulation should not exceed 75kHz.
11. Check the documentation that came with your audio processor on how to set/check the proper pilot injection level.
12. Check the documentation that came with your RDS encoder on how to set/check the proper RDS injection level.

In this setup, the audio stereo multiplex is generated in the audio processor. The RDS data is fed into the audio processor where it is combined with the audio multiplex. This combined signal is fed directly into the transmitter exciter. Note that the transmitter's onboard processing will have no effect on the signal in this configuration. This is the best connection in terms of pilot and RDS subcarrier phase synchronization and MPX spectrum cleanliness.

Part III

System Configuration

Operation Guide



7.1 RF Settings

N.B. Never power on an FM transmitter without a suitable antenna or dummy load connected. The V2 Transmitter's protection circuitry will prevent any internal damage, but it is not advisable to run an FM transmitter without a load connected.

7.1.1 Basic Setup

1. Select the required **Frequency**. Note that the frequency displayed on the Status box will flash for a few seconds, indicating that the system is out of lock and has not reached the frequency. Once locked, the value will become steady.
2. Select the required **Power**. The system will take some time to ramp the power to the selected value. During this time, the value displayed in the Status box will flash.
3. Set the **MPX Source** parameter. This selects the source for the exciter. Select *Internal* if the analog/digital inputs are used. (which are connected to the built-in audio processor) or *External* if the transmitter is used with an external audio source connected to its MPX BNC input.
4. Select whether you require the unit to send the **FSK ID** every hour. If enabled, enter the **FSK ID**.
5. If the unit is required to mute the RF output on silence detection, then select set **RF Mute on Silence** to the amount of time after which the transmitter's output will be muted if the transmitter is transmitting silence. (Note that the unit understands silence as a signal that produces less than 30 kHz modulation. Look at the Deviation meter "DEV:" on the status box).
6. **RF Mute (Manual)** must be switched to *off* (once the unit is set-up) to begin transmission.

7.1.2 Power Scheduler

This feature will switch the output power of the unit to an alternate value set at **Power Scheduler** ⇒ **Power** during the selected time interval. This feature is intended to allow users to lower the power of their transmission at night time to reduce power consumption and avoid increasing the range of the transmission due to the change in atmospheric conditions.

In order to setup the feature:

1. In **Power**, select the power that the unit will use during the scheduled interval
2. Select the **Start Time** at which the unit will switch to the alternate scheduled power.

3. Select the **Finish Time** at which the unit will switch to the normal power **RF Settings** ⇒ **Power**.
4. **Current Time** is the system time. This is displayed here as a reference for selecting the start and finish times. It can also be adjusted if required.
5. Set **Enable** to *Enabled*. The power Scheduler is now running.

7.2 Audio Settings

BW Broadcast's range of award winning DSPX audio processors has become known for their features, performance and value for money. Integrated within all V2 Transmitters is the 4-band DSPXmini FM SE. The analogue and digital inputs (XLRs) are connected to the processor.

Set up:

1. Select MPX source as required. Set to **Internal** if the analog or digital inputs (XLRs) are used or **external** if the "MPX in" BNC socket is used (e.g.: to connect an external audio processor).

When set to *Internal*, the built-in audio processor will be used. In this case:

1. Set the **Audio Input** to *Analog or Digital*.
2. Set the required **Processing preset**.
3. Select the desired **Pre-emphasis** characteristic (*off, 50us (for EU) or 75us (for Americas)*)
4. Select the **Audio Mode** (*Stereo, Mono L+R, Mono L, Mono R, Swap L/R*). Selecting mono disables the stereo pilot and subcarrier.

7.3 Triggers

V2 Transmitters have a comprehensive monitoring and control system consisting of 3 alarms and 4 triggers. Pin 2 of the connector is hardwired to RF mute. Connecting this pin to ground will mute the transmitter. The alarms and triggers port can also be used to control the unit through a telemetry interface system. Trigger pins are designed to work with relay contacts to ground or 5 V drivers able to sink 15 mA (per trigger pin).

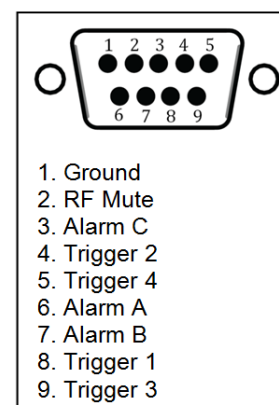

Figure 7.1: Alarms and Triggers Port

Triggers are used to control certain parameters on the V2 Transmitter using the relevant pins on the rear alarms and triggers connector. To fire a trigger, the pin must be pulled low.

To set up a trigger:

1. Connect the required trigger pin to the required source. Make sure that the voltage and current levels are compatible.
2. Navigate to the Triggers folder and enter the required trigger folder (**Trigger 1, ..., Trigger 4**).
3. Set **Enable** to *Enabled*.
4. Select the **Action** that the trigger will perform. Options are: *Frequency Up, Frequency Down, Power Up, Power Down, RF Mute* and *Reboot*. *Frequency Up, Frequency Down, Power Up, Power Down* and *reboot* will perform the action on falling edges of the signal on the trigger pin. *RF Mute* acts based on voltage levels. RF Mute will be engaged for as long as the trigger signal is pulled low and unmute when the signal is high.
5. If you require email alerts, set **Send e-mail** to Yes. Make sure e-mails are setup correctly. (Refer to the e-mails section in this manual)
6. If **Send e-mail** is set to Yes, enter the **(ON) Message** that the trigger will send when fired.

7.4 Alarms

Alarms on the V2 Transmitter indicate that a failure condition is met. They can be set to go off on Modulation level, Forward power, Reverse power and PLL lock fail. Upon triggering they will toggle the relevant pin on the rear alarms and trigger connector. They will also write a notification to the RS232, write to the system log and send an e-mail if required. Alarm pins can be configured as open-collector Outputs (when working as alarms) or as Analog outputs (for reporting system parameters as analog voltages). When used as alarms, 10 kOhm external pull-up resistors to 12 V should be placed on each pin to be able observe voltage changes in the alarm pins.

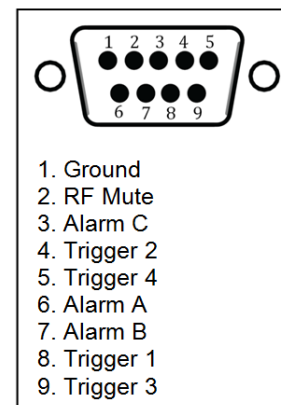

Figure 7.2: Alarms and Triggers Port

To set up an Alarm pin as *Alarm*:

1. If required, connect the required alarm pin to the external measuring equipment. Observe correct current and voltage ratings. Note that an external pull-up resistor may be required.

2. Navigate to the Alarms folder and then enter the Alarm folder that you require (Alarm A, B, C).
3. Set **Type** to *Alarm*.
4. Set the source for the **Alarm**. For a detailed description consult the parametric guide section on Alarms.
5. Set the **Threshold** for the selected fail condition.
6. Set the **Pin Polarity**
7. Set the **On Delay**
8. Set the **Off Delay**
9. If an e-mail notification is required, set **Send e-mail** to Yes. Make sure that e-mails are set up correctly.

To set up an Alarm pin as *Analog Output*:

1. Connect the required alarm pin to the external measuring equipment. Observe correct current and voltage ratings. Note that an external pull-up resistor may be required.
2. Navigate to the Alarms folder and enter the Alarm folder that you require (Alarm A, B, C, ..).
3. Set **Type** to *Analog Out*.
4. Set the **Source** for the Analog Out. For a detailed description consult the parametric guide section on Alarms.

7.5 System

7.5.1 Real Time Clock

1. Set the **Date** (day Month Year)
2. Set the **Time** (hh:mm:ss). It is important to set up the clock and date for support diagnostics.

7.5.2 Unit Information

1. Set **Location** (a brief description of the physical location of the device)
2. Set **Contact** (Name of the person who manages the unit)

7.5.3 Screen Saver

1. Select the **Screen Saver** time-out before the Screensaver starts.
2. Enable or disable **Screen Lock** as required. If enabled, enter the desired 4 digit **Screen Lock Code**. This code will be requested in order to exit the screen saver screen.

7.5.4 Users

1. Enter the **Username** for the remote login.
2. Enter the **Password** for the remote login.

7.5.5 Ethernet

Enable or Disable **DHCP** as required.

With **DHCP** set to *off* (Static IP):

1. Enter the **Static IP**
2. Enter the **Static SM**
3. Enter the **Static GW**
4. Enter the **Static DNS 1**
5. Enter the **Static DNS 2**
6. The **MAC** address of the unit is displayed here and can be used for setting up the network.

With **DHCP** set to *on* (Static IP):

1. The system will take some time (usually a few seconds, depending on the network setup) to gather the required IP configuration from the DHCP server.
2. Once the unit has received the IP configuration information, it will display it in the following parameters: **DHCP IP, DHCP SM, DHCP GW, DHCP DNS 1, DHCP DNS 2**.
3. The "Static" Parameters are shown but are not used.

7.5.6 E-Mail

V2 Transmitters can send e-mails to provide notifications of alarms or external triggers becoming active. The transmitter can either send emails via a user defined SMTP server or an SMTP server hosted by BW Broadcast. Please note that SSL authentication is not supported by the unit. The easier option to set up is to send the email via the *BW Broadcast* email relay service. In this case, the unit must be connected to the internet in order to connect to the service. Ensure the unit is connected to an Ethernet socket and Ethernet is set up correctly to use this feature.

Sending emails via your own SMTP server (SSL is not supported):

1. Set **Send via** to *SMTP*.
2. Enter the email address of the sender in **From**.
3. Enter the email address(es) of the receiver(s) in **Recipient(s)**. Separate receivers by commas.
4. Enter the IP address of the SMTP server in **Host**
5. Enter the Port number of the SMTP server in **Port**
6. Enter the **Username** for SMTP authentication. If no authentication is required, this field must be left blank.
7. Enter the **Password** for the SMTP authentication. If no authentication is required, this field must be left blank.
8. Set **Max emails a day** to the maximum number of emails allowed to be sent by the unit in a single day.
9. Enter the **Test** folder and set the **Recipient(s)** for this test email.
10. Set **Test** to Yes. Check if the e-mail has been received.

Sending emails via *BW Broadcast* email relay:

1. Set **Send via** to *BW Broadcast*.
2. Enter the email address of the sender in **From**.
3. Enter the email address(es) of the receiver(s) in **Recipient(s)**. Separate receivers by commas.
4. Navigate to the **Test** folder (**System** ⇒ **E-Mail** ⇒ **Test**) and enter the **Recipient(s)** for this test email.
5. Set **Test** to Yes. Check if the e-mail has been received.

7.5.7 HTTP

V2 Transmitters provide a graphical web based interface for ease of use and control. This can be accessed by navigating to the IP address of the unit in any standard web browser. After entering the login details for the unit, the user can then read and write all parameters and also perform firmware upgrades. All parameters are saved and updated dynamically as they are changed in the remote.

Ensure the unit is connected to an Ethernet socket and Ethernet is set up correctly to use this feature.

By default, HTTP is enabled and running on port 80. In order to change these settings:

1. Navigate to **System** ⇒ **HTTP**.
2. Set **Enable** to *Disabled*.
3. Set the Webserver TCP port number in **Port**.
4. Set **Enable** to *Enabled*.
5. The **Remote Control Indication** parameter can be set to *Enabled* or *Disabled*. If set to *Enabled*, the system will show a message on the screen when being controlled through the web remote.

For further information on how to use the web remote, please refer to the "Web Remote Tutorial" section.

7.5.8 Telnet

V2 Transmitters offer many options for remote monitoring and control. All parameters available on the front panel are available remotely. For text based access via a local network or the internet, Telnet can be used to connect to the unit. By default, Telnet is enabled on port 23. In order to change these settings:

1. Navigate to **System** ⇒ **Telnet**.
2. Set **Enable** to *Disabled*.
3. Set the required **Port** number.
4. Set **Enable** to *Enabled*.

For further information on how to use the Telnet remote, refer to the "**Text Based Access**" section.

7.5.9 RS232

V2 Transmitters offer many options for remote monitoring and control. All parameters available on the front panel are available remotely.

To connect to the unit via RS232 connection, connect a standard serial cable between the transmitter and the PC, and use the following settings for the COM port:

- Baud rate - Selected Baud rate set in the Unit (default: 19200bps)
- Data Bits - 8
- Parity - None
- Stop Bits - 1
- Flow Control - Hardware

In order to change these settings in the unit:

1. Navigate to **System** ⇒ **RS232**.
2. Enable or disable the feature by adjusting the **Enable** parameter.
3. Select the required **Baud rate** for the connection.

7.5.10 Log

V2 Transmitters have three methods of logging. Regardless of the log location, the format is the same. V2 Transmitters will output a list of important parameters, all meter settings and alarm and trigger statuses 2 minutes after a parameter change and then at hourly intervals. These can be either received via RS232, UDP or saved to a file on the internal memory of the transmitter. Each method can be enabled or disabled. In order to enable/disable the different logging methods, navigate to **System** ⇒ **Log** and set the different methods to *Enabled* or *Disabled*.

UDP will send the log messages via UDP to an IP address. In order to change the UDP settings:

1. Navigate to **System** ⇒ **Log** ⇒ **UDP**.
2. Set **Enable** to *Disabled*.
3. Set the **IP** address where the log message should be sent via UDP.
4. Set the **Port** number.
5. Set **Enable** to *Enabled*.
6. Ensure that the unit is connected to an Ethernet socket and Ethernet is set up correctly to use this feature.

Logging to a File in internal memory

If enabled, the system will keep logs of the last 31 days. These logs can be accessed through the web remote.

An example section from a log file is shown below:

2013-04-22 11:40:06 DTLG > M: exciter_locked = 1

DTLG > M: peak_deviation = 75k

DTLG > M: fwd_power = 250

DTLG > M: rev_power = 3

DTLG > M: pa_voltage = 30.1

DTLG > M: aux_voltage = 15.1

DTLG > M: pa_temp = 30.0

DTLG > M: cpu_temp = 25.0

DTLG > M: tx_input_l = -38.997

DTLG > M: tx_input_r = -38.997

DTLG > M: agc1 = 0m

DTLG > M: agc2 = 0m

DTLG > M: agc3 = 0m

DTLG > M: agc4 = 0m

DTLG > M: lim1 = -5997m

DTLG > M: lim2 = -5997m

DTLG > M: lim3 = -5997m

DTLG > M: lim4 = -5997m

DTLG > M: tx_output_l = -14.000

DTLG > M: tx_output_r = -14.000

DTLG > M: tx_output_mpx = 0m

DTLG > P: transmitter.frequency = 98.00MHz

DTLG > Alarm status [3-0]: Off Off On Off

DTLG > Trigger status [3-0]: On On On On

7.5.11 Diagnostics

This set of parameters report the state of various parts of the system upon boot (OK or fail). If an error condition is observed, the unit should be re-booted and these parameters should be examined. This information will be useful when contacting support.

7.5.12 About

The about menu contains the version numbers of the different parts of the system. These values should be available when contacting support.

7.5.13 Reboot

This parameter will reboot the unit.

7.5.14 Factory Reset

Performs a factory reset, setting all the parameters to its default value except for Network settings. All user changes will be lost.

7.6 Web Remote

V2 Transmitters provide a graphical web based interface for ease of use and control. This can be accessed by navigating to the IP address of the unit in any standard web browser. After entering the login details for the unit, the user can then read and write all parameters and also perform firmware upgrades. All parameters are saved and updated dynamically as they are changed in the remote. The system serves a mobile-optimised version when accessed from a mobile web browser.

7.6.1 Authentication

Browse to the IP of the unit (Navigate to **System** ⇒ **Ethernet** in the FP. Refer to the Ethernet section in this manual to set up Ethernet). You will be required to authenticate by entering the password. This password must match the one selected in the FP (**System** ⇒ **Users** ⇒ **Password**). The default password is "pass".

7.6.2 Web Remote Interface

The user interface is divided in several sections: Status Bar, Alarms and Notifications, Navigation Bar and Transmitter Controls.

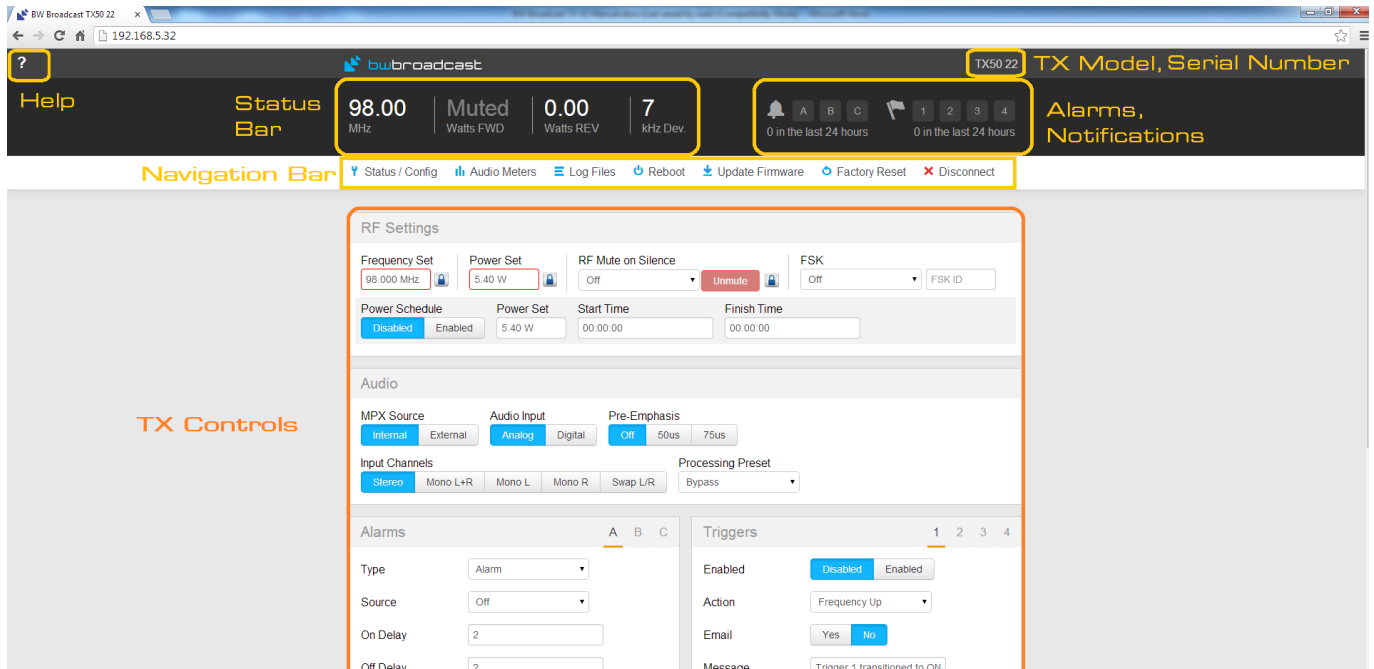

Status Bar

The Status Bar displays the current status of the Transmitter (Frequency, FWD power in Watts, REV power in Watts, peak Deviation in kHz).

Alarms and Notifications

The Alarms and Notifications Section displays the status of the alarms and the number of times that the alarms were fired in the last 24 hours. The Notifications section reports the number of emails sent by the unit within the last 24 hours.

Navigation Bar

This Bar Contains shortcuts that bring up the relevant windows connected to the feature:

A Status/Config

This Brings up a box with all the relevant Status and configuration settings. There are: RF Status, Audio Status, Unit Status, Trigger Status, Trigger Config, Alarm Status, Alarm Config, Location, Contact, Date and Time, Uptime, Network, Web Portal, Telnet, RS232, System Details.

B Audio Meters

This Brings up a box with a graphical representation of the Audio Meters (Input, AGC, Limiters, Output, MPX).

C Log Files

This brings up a box with a collection of all the logs stored in the unit. The latest log (today's log) is displayed by default (TX-V2.log). Older logs can be selected from the list. If the unit has been switched on all the time, TX-V2.log.1 corresponds to yesterday's log, TX-V2.log.2 corresponds to the log written two days ago and so on. Note that if the unit is switched off, it will not write to the log and it will not create a new log file for the number of days it is off, so the older log files in this case will correspond to previous logs (written several days ago).

Another way of accessing the logs, which may be useful in some cases where the log file contents need to be copied, is by browsing to a specific URL: <http://IPAddress/TX-V2.log>

For example (*IPAddress* = 192.168.5.32). For today's log:

<http://192.168.5.32/TX-V2.log>

Yesterday's log:

<http://192.168.5.32/TX-V2.log.1>

Previous logs:

<http://192.168.5.32/TX-V2.log.x>

D Reboot

This will reboot the unit.

E Update Firmware

This option allows you to upgrade the Firmware of the unit. Click on "Choose File" and select the desired upgrade.dat file. Then click update and wait while the unit receives the new SW and upgrades the system. The webpage will refresh in 5 minutes. The upgrading process may be finished in two minutes so try refreshing the page after this time.

Software Upgrade files can be downloaded from <http://www.bwbroadcast.com/downloads>. These bring new features and improvements to the unit.

F Factory Reset

This option resets the unit, bringing all parameters to their default value. Network settings are not affected.

G Disconnect

Clicking this button closes the active web remote session.

H Transmitter Controls

All the controls in the transmitter can be found in this section. These are the same options that can be found in the Front Panel Control System on the transmitter itself. Click on the Help Icon (?) located on the top left of the screen or refer to the relevant sections of this manual to understand any particular feature.

I TX Model and Serial Number Indicator

The TX Model and product Serial Number are displayed on the top right of the page.

7.7 Text Based Access (Telnet or Serial RS232)

The unit offers text based access via a local network or the internet through Telnet or serial RS232.

7.7.1 Commands

The following commands are available:

Command	Description
help	Displays help message
get	Gets a parameter
set	Sets a parameter
reboot	Reboots the unit
factoryReset	Restores all settings to factory default except for Ethernet settings

help

This command (without any arguments) displays a list of the commands the unit understands.

help parameter_id This command displays a short description of the requested parameter. e.g.:

```
"TX V2> help transmitter.power
```

```
transmitter.power: Sets the output power level in watts. This parameter accepts values from 0 to 600."
```

get parameter_id

This command returns the current value of the parameter requested. e.g.

```
TX V2> get transmitter.frequency
```

```
98.00MHz
```

set parameter_id parameter_value

This command sets the parameter requested to the value specified. e.g.

```
TX V2> set transmitter.power 150
```

```
OK
```

reboot

This command reboots the unit.

Please note - there will be no confirmation stage, if you send this command the unit will reboot immediately, taking your transmitter temporarily off-air.

factoryReset

This command resets all values to their default apart from the Ethernet settings of the unit.

Please note - there will be no confirmation stage, if you send this command the unit will revert all settings to factory defaults which may result in a temporary loss of signal.

7.8 Web API

All the parameters in the unit can be read or set using standard HTTP requests in the fashion of, for example, "http://192.168.5.34/api/getParameter?id=transmitter.power"

7.8.1 Authentication

Logging in

In order to be able to read or modify parameters through the Web API, the user must first authenticate by sending the following request:

```
"http://IP_ADRESS/api/auth?password=PASSWORD"
```

Where *IP_ADRESS* is the IP Address of the unit and *PASSWORD* is the password set in the Font Panel (**System** ⇒ **Users** ⇒ **Password**)

The unit will respond with a page with xml content (text/xml) and the following content if the login attempt is correct:

```
<response login="true" sid="884498006"/>
```

Note that the sid value will be different in different sessions.

Logging Out

The following request performs a 'log out'. This request should be issued when finished using the unit through the Web API.

```
"http://IP_ADDRESS/api/logout"
```

7.8.2 Setting A Parameter

To set parameters, use the following request:

```
"http://IP_ADRESS/api/setParameter?id=PARAMETER_NAME&value=PARAMETER_VALUE"
```

The unit will respond with a page with xml content (text/xml) and the following if the request was successful:

```
"<response success="true"/>"
```

Please refer to the "Parameter list" subsection for a list with all the parameters available in the unit.

E.g. To set the frequency to 99 MHz, issue the following request:

```
"http://192.168.5.34/api/setParameter?id=transmitter.frequency&value=99M"
```

Note that for parameters containing brackets in their name (such as alarm[1].email.active), these characters should be escaped and must be written as "%5B" and "%5D" in the html request. E.g.:

```
"http://192.168.5.34/api/setParameter?id=alarm%5B1%5D.email.active&value=yes"
```

7.8.3 Reading Parameters

Reading one Parameter

To get the value of a specific parameter, use the following request:

```
"http://IP_ADRESS/api/getParameter?id=PARAMETER_NAME"
```

e.g:

```
"http://192.168.5.34/api/getParameter?id=transmitter.power"
```

Response with xml content (text/xml):

```
"<parameters> <parameter id="transmitter.power" value="5.40"/> </parameters>"
```

Reading all the Parameters

To get a list with all the parameters, use the following request:

```
"http://IP_ADRESS/api/getparameters"
```

e.g.:

```
"http://192.168.5.34/api/getParameters"
```

Response with xml content (text/xml):

```
<parameters lastmodified="1391767126">  
  <parameter id="system.contact" value=""/>  
  <parameter id="system.location" value=""/>  
  <parameter id="system.username.admin" value="admin"/>  
  <parameter id="system.password.admin" value="pass"/>  
  <parameter id="system.uptime" value="0 days, 00:09:42"/>  
  <parameter id="system.screen.timeout" value="300"/>  
  <parameter id="system.screen.lock.enabled" value="off"/>  
  ... ..  
  ... ..  
  ... ..  
  <parameter id="powerscheduler.finishime" value="00:00:00"/>
```

```
<parameter id="powerscheduler.power" value="5.40"/>
</parameters>
```

7.8.4 Reading Meters

The following request will return a page with all the values for the different meters:

```
"http://IP_ADRESS/api/streammeters"
```

7.8.5 Reading log files

The following request will return a page with the latest log contained in the unit (today's log):

```
"http://IP_ADRESS/TX-V2.log"
```

To access old log files, use the following requests:

For yesterday's log:

```
"http://IP_ADRESS/TX-V2.log.1"
```

Two days ago:

```
"http://IP_ADRESS/TX-V2.log.2"
```

n days ago:

```
"http://IP_ADRESS/TX-V2.log.n"
```

7.9 Parameters

This section contains a list of all the parameters in the unit and all of their possible values. This should must be used as a reference when controlling the unit via text based access (Telnet or Serial RS232) or the Web API.

When setting the value of a parameter, trying to set a value greater than the allowed maximum will result in the maximum value being set. When setting a value less than the allowed minimum, the minimum value will be set. When setting a parameter to a value which does not align to the step size of that particular parameter, the closest lower value multiple of the step size will be set.

Setting values allows the use of prefixes. available prefixes are: m (mili = *0.001), k or K (kilo = * 1000), M (Mega = * 1000). These can be used when setting a parameter value. E.g.:

Setting the frequency to 98 MHz:

```
"set transmitter.frequency 98M"
```

```
"set transmitter.frequency 98000K"
```

```
"set transmitter.frequency 98000000"
```

7.9.1 RF Settings

Frequency transmitter.frequency

Range: Frequency in Hz (87.5MHz to 108MHz for Normal Band II transmitters).

e.g.: "set transmitter.frequency 90M"

or "set transmitter.frequency 90000k"

or "set transmitter.frequency 90000000"

Power transmitter.set_power

Range: Power in Watts (depending on the TX Model, see attached table)

Transmitter Model	Minimum Power	Maximum Power	Step Size
TX5	0.05	5.05	0.05
TX30	5.4	30.15	0.45
TX50	5.4	50.4	0.45
TX300	30.8	310.8	2.8
TX600	60.5	610.5	5.5
TX1000	152	1102	9.5
TX1500	162	1512	13.5
TX2500	520.5	2550	20.5

e.g.: "set transmitter.set_power 50"

MPX Source mpx.source

Options: int (for internal), ext (for external)

FSK transmitter.fsk_interval

Options: off, 3600 (sends every hour)

FSK ID transmitter.fsk_id

Accepts up to 16 characters of text

RF Mute on Silence transmitter.rf_mute.timeout

Options: off, 60 (for 1 minutes), 600 (for 10 min), 1800 (for 30 min), 3600 (for 1 hour)

RF Mute Manual transmitter.rf_mute.manual_enable

Options: on (mutes the transmitter), off (unmutes the transmitter)

Power Scheduler

Enable powerscheduler.enabled

Options: off (disabled), on (enabled)

Power powerscheduler.power

Range: Power in Watts (depending on the TX Model, see attached table)

Start Time powerscheduler.starttime

Range: time in format hh:mm:ss or hh.mm.ss

e.g.: "set powerscheduler.starttime 12:30:30"

Finish Time powerscheduler.finishtime

Range: time in format hh:mm:ss or hh.mm.ss

Current Time system.time

Range: time in format hh:mm:ss or hh.mm.ss

This parameter can be get or set.

7.9.2 Audio Settings

MPX Source mpx.source

Options: *int* (for internal), *ext* (for external)

Audio Input audio.input

Options: *analog*, *digital*

Processing Preset audio.processing_preset

Options: 8 to 22.

Value	Preset
8	Bypass
9	AC
10	CHR
11	Tight
12	Hot
13	Loud
14	Smooth
15	Clean
16	Bright
17	RockNRoll
18	Low Bass
19	Urban
20	Talk
21	Classic Bright
22	Classic Bright 2

Pre-Emphasis audio.preemphasis

Options: Options: 0 (for Off), 50 (50 us), 75 (75us)

Audio Mode audio.stereo

Options: *stereo*, *mono_lr* (for Mono L+R), *mono_l* (Mono L), *mono_r* (Mono R), *swap_lr* (Swap L/R)

7.9.3 Triggers

The following parameters can be used to configure any trigger (trigger[x], where x is 1 to 4)

Enable trigger[x].active

Options: *off*, *on*

Action trigger[x].action

Options: *fup* (for Frequency Up), *fdown* (Frequency Down), *pup* (Power Up), *pdown* (Power Down), *rfmute* (RF Mute), *reboot* (Reboot)

Send e-mail trigger[x].email.active

Options: Options: *yes*, *no*

(ON) Message trigger[x].message.on

Accepts up to 300 characters of text.

7.9.4 Alarms

Type alarm[x].type

Options: *alarm*, *telemetry* (for Analog Out)

Source (for Analog Out) alarm[x].telemetrysource

Options: *fwdpow* (for Fwd Power), *revpow* (Rev Power), *pavolts* (PA Volts), *auxvolts* (Aux Volts), *peakmod* (Peak Modulation), *patemp* (PA Temp), *rfmute* (RF Mute),

Modulation Threshold alarm[x].modulation_threshold

Range: 1000 to 100000.

Fwd Power Threshold alarm[x].fwd_power_threshold

Range: 0 to double the Maximum Power of the transmitter (Refer to transmitter.set_power).

Rev Power Threshold alarm[x].rev_power_threshold

Range: 0 to double the Maximum Power of the transmitter (Refer to transmitter.set_power).

Pin Polarity alarm[x].polarity

Options: *positive* (for +ve), *negative* (for -ve)

On Delay alarm[x].on_delay

Range: 2 to 600 (seconds)

Off Delay alarm[x].off_delay

Range: 2 to 600 (seconds)

Send e-mail alarm[x].email.active

Options: *yes*, *no*

7.9.5 System

Date system.date

Range: Date in the following format yyyy-mm-dd

e.g.: "set system.date 2014-02-22"

Time system.time

Range: Time in the following format hh.mm.ss

e.g.: "set system.time 22:10:55"

Uptime system.uptime

Read only (get system.uptime) (reads: x days, hh:mm:ss)

Location system.location

Range: Up to 64 characters of text.

Contact system.contact

Range: Up to 64 characters of text.

Screen Saver system.screen.timeout

Options: 15, 30, 60 (for 1 min), 120 (2min), 180 (3 min), 300 (5 min), 600 (10 min), 900 (15 min), 1200 (20 min), 1500 (25 min), 1800 (30 min)

Screen Lock system.screen.lock.enabled

Options: *off*, *on*

Screen Lock Code system.screen.lock.code

Range: 4 digits (xxxx) e.g.: "set system.screen.lock.code 1234"

Users

Username system.username.admin

Range: up to 15 characters of text.

Password system.username.password

Range: up to 15 characters of text.

Ethernet

DHCP system.ethernet.dhcp

Options: *off, on*

DHCP IP system.ethernet.dhcp.ip

Range: Read only. Reads IPv4 address in the form aaa.bbb.ccc.ddd

DHCP SM system.ethernet.dhcp.sm

Range: Read only. Reads IPv4 address in the form aaa.bbb.ccc.ddd

DHCP SM system.ethernet.dhcp.sm

Range: Read only. Reads IPv4 address in the form aaa.bbb.ccc.ddd

DHCP GW system.ethernet.dhcp.gw

Range: Read only. Reads IPv4 address in the form aaa.bbb.ccc.ddd

DHCP DNS1 system.ethernet.dhcp.dns[1]

Range: Read only. Reads IPv4 address in the form aaa.bbb.ccc.ddd

DHCP DNS2 system.ethernet.dhcp.dns[2]

Range: Read only. Reads IPv4 address in the form aaa.bbb.ccc.ddd

Static IP system.ethernet.static.ip

Range: Read only. Reads IPv4 address in the form aaa.bbb.ccc.ddd

Static SM system.ethernet.static.sm

Range: Read only. Reads IPv4 address in the form aaa.bbb.ccc.ddd

Static GW system.ethernet.static.gw

Range: Read only. Reads IPv4 address in the form aaa.bbb.ccc.ddd

Static DNS 1 system.ethernet.static.dns[1]

Range: Read only. Reads IPv4 address in the form aaa.bbb.ccc.ddd

Static DNS 2 system.ethernet.static.dns[2]

Range: Read only. Reads IPv4 address in the form aaa.bbb.ccc.ddd

MAC system.ethernet.mac

Range: Read only. xx:xx:xx:xx:xx:xx

E-Mail

Test email.test.send

Options: yes (to send a test email. It will automatically go back to no)

Recipient(s) (For the test e-mail) email.test.recipient

Range: Accepts text up to 99 characters. Multiple addresses must be separated by commas.

Send Via email.method

Options: *SMTP, BWBroadcast*

From email.from

Options: Accepts up to 64 characters of text.

Recipient(s) email.recipient

Range: Accepts up to 99 characters of text.

Port smtp.port

Range: 1 to 1024

Username smtp.username

Range: Accepts up to 64 characters of text

Password smtp.password

Range: Accepts up to 64 characters of text

Max emails a day email.limit.daily

Range: 1 to 1000

Emails sent today email.counter.today

Range: Read only 1 to 100000

HTTP

Enable system.httpd.active

Options: *off, on*

Port system.httpd.port

Range: 1 to 1024

Remote Control Indication system.httpd.remote_control_message

Options: *off, on*

Telnet

Enable system.telnetd.active

Options: *off, on*

Port system.telnetd.port

Range: 1 to 1024

RS232

Enable system.rs232d.active

Options: *off, on*

Baud rate system.rs232d.baud

Options: *9600, 19200, 38400, 57600, 115200*

Log

RS232 system.logging.rs232.active

Options: *off, on*

File system.logging.file.active

Options: *off, on*

Log: UDP

Enable system.logging.udp.active

Options: *off, on*

IP system.logging.udp.ip

Range: IPv4 address in the form aaa.bbb.ccc.ddd

Port system.logging.udp.port

Range: 1 to 10000

Diagnostics

DSPX Comm system.diagnostics.dspcx

Options: Read only (*OK, FAIL*)

Exciter Comm system.diagnostics.exciter

Options: Read only (*OK, FAIL*)

Alarms DAC system.diagnostics.alarmsdac

Options: Read only (*OK, FAIL*)

Power DAC system.diagnostics.power.dac

Options: Read only (*OK, FAIL*)

About

Product ID system.product.id

Range: Read only. Reads back the product ID (TXxxx) e.g.: "TX50".

Product Version system.product.version

Range: Read only. Reads back the product version (e.g.: "3.3").

Serial Number system.serial_number

Range: Read only. Reads back the Hardware version (e.g.: "12").

Hardware Version system.hardware.version

Range: Read only. Reads back the Software version (e.g.: "1.5").

Software Version system.software.version

Range: Read only. Reads back the serial number (e.g.: "1045").

Control Version system.control.version

Range: Read only. Reads back the Control version (e.g.: "1.0").

AIO FW Version system.aio_fw.version

Range: Read only. Reads back the Software version (e.g.: "1.5").

Reboot

Reboot system.reboot

Options: yes (to perform the reboot). Note that the unit will close the Telnet connection. You will need to reconnect after a few seconds to allow the unit to reboot.

Factory Reset

Factory Reset `system.factory_reset`

Options: yes (to perform the factory reset). Note that all the user settings will be lost and unit will load the default values for all the parameters.



Parameter Guide

8.1 RF Settings

8.1.1 Frequency

This sets the transmission frequency. The range for this parameter depends on the Band. For normal Band II transmitters the range is 87.5 MHz to 108 MHz. The normal step size is 50 kHz.

Other frequency ranges and step sizes are also available on request. Please contact a sales representative for more information.

8.1.2 Power

This sets the RF output level in watts. The range and the step size for this parameter depend on the model of the transmitter. The following table lists all the ranges for the different models in Watts:

Transmitter Model	Minimum Power	Maximum Power	Step Size
TX5	0.05	5.05	0.05
TX30	5.4	30.15	0.45
TX50	5.4	50.4	0.45
TX300	30.8	310.8	2.8
TX600	60.5	610.5	5.5
TX1000	152	1102	9.5
TX1500	162	1512	13.5
TX2500	520.5	2550	20.5

Note that when setting the power, the unit will automatically adjust the power output to reach the selected value. This may take a few seconds. During this time, the FWD power indicator in the Status Box will flash to indicate that the unit is still adjusting to reach the selected power.

8.1.3 MPX Source

This selects the source for the exciter. Options are *Internal* or *External*. *Internal* selects the internal generator, i.e. the output from the internal audio processor. This option must be selected when the digital or analog inputs are used. *External* selects the MPX BNC input. This option must be selected when the transmitter is used with an external audio processor connected to the MPX BNC input.

8.1.4 FSK (for translators in the USA)

V2 Transmitters support automatic station identification using frequency shift keying (FSK). FSK sends a user defined ID once every hour using Morse code and shifting the carrier frequency up by 12.5kHz at 20 words per minute.

FSK ID

If enabled, the **FSK ID** will be sent once every hour. The required station ID must be entered in **FSK ID** (up to 16 characters).

8.1.5 RF Mute on Silence

This selects the time after which the transmitter's RF output will be muted if the transmitter is transmitting silence. Options are: off, 1 min, 10 min, 30 min and 1h. The transmitter identifies silence as a signal that produces a deviation of less than 30 kHz for the time period selected.

The Status box will indicate that the output of the transmitter is muted:

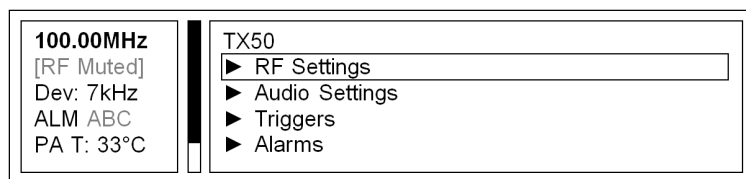

8.1.6 RF Mute (Manual)

This will manually mute the transmitter. The Status box will indicate that the output of the transmitter is muted as shown in the picture above.

8.1.7 Power Scheduler

This feature allows the unit to be configured for transmitting different RF power levels at different times of the day. The unit will normally transmit the signal at the power specified in **RF Settings** ⇒ **Power**. If the power scheduler is disabled, the unit will keep transmitting at this power level all of the time. If the Power Scheduler is enabled, the unit will switch to the selected scheduled power (**Power Scheduler** ⇒ **Power**) when the time matches the **Start Time** and will return to normal power when the time matches **Finish Time**.

This feature is intended to allow users to lower the power of their transmission at night time to reduce power consumption and avoid increasing the range of the transmission due to the change in atmospheric conditions. Please adhere to your licensing restrictions on power.

Enable

Enables/disables Power Scheduling.

Power

Selects the power that the transmitter will produce during the scheduled interval.

Start Time

Selects the time at which the output power will change from normal power to scheduled power.

Finish Time

Selects the time at which the output power will change from scheduled power to normal power.

Current Time

Current time set in the unit. It can be modified to adjust the time in the Real Time Clock.

8.2 Audio Settings

8.2.1 MPX Source

This is the same parameter as described in RF Settings. It has been placed in the Audio settings menu for convenience of access. This selects the source for the exciter. Options are *Internal* or *External*. *Internal* selects the internal generator, i.e. the output from the internal audio processor. This option must be selected when the digital or analog inputs are used. *External* selects the MPX BNC input. This option must be selected when the transmitter is used with an external audio processor connected to its MPX BNC input.

8.2.2 Audio Input

Selects *Digital* or *Analog* as the audio input. These are the XLR connectors in the back panel. Note that the MPX Source parameter must be set to *Internal* to use the analog or digital inputs.

8.2.3 Processing Preset

BW Broadcast's range of award winning DSPX audio processors has become known for their features, performance and value for money. Integrated within all V2 Transmitters is the 4-band DSPXmini FM SE. This parameter selects the audio processing preset that the internal audio processor will use. Options are: *Bypass, AC, CHR, Tight, Hot, Loud, Smooth, Clean, Bright, RockNRoll, Low Bass, Urban, Talk, Classic Bright, Classic Bright2*. Each processing preset provides a different overall sound. Try and experiment with different presets to find out which one is more suitable for your program material. Each processing preset is loaded live as the user scrolls through the menu allowing for easy comparison between them. A dedicated metering screen (Audio Status) indicates the input levels, 4 band automatic gain control and limiters, along with audio level and MPX level meters. The *Bypass* preset can be used to bypass the internal processing. This is useful when using an external audio processor connected to the digital/analog inputs. In this case, an 8dBu signal on the back panel analogue input (or -18DBFS on AES inputs) should be used to align to the safety clipper thresholds of the internal processor. Make sure **Pre-emphasis** is *off* when using the *Bypass* preset. Another option for bypassing the internal audio processor is to use the external MPX input. In this case, the **MPX Source** parameter must be set to *External*.

8.2.4 Pre-emphasis

This parameter allows you to select the desired preemphasis characteristic (*off, 50us or 75us*). Make sure **Pre-emphasis** is *Off* when using an external processor connected to the analog or digital inputs and select *Bypass* as the **Processing Preset**.

8.3 Triggers

V2 Transmitters have a comprehensive monitoring and control system consisting of 3 alarms and 4 triggers. Pin 2 of the connector is hardwired to RF mute. Connecting this pin to ground will mute the transmitter. The alarms and triggers port can also be used to control the unit through a telemetry interface system. Trigger pins are designed to work with relay contacts to ground or 5 V drivers able to sink 15 mA (per trigger pin). Triggers are used to control certain parameters on the V2 Transmitter using the relevant pins on the rear alarms and triggers connector. To fire a trigger, the pin must be pulled low.

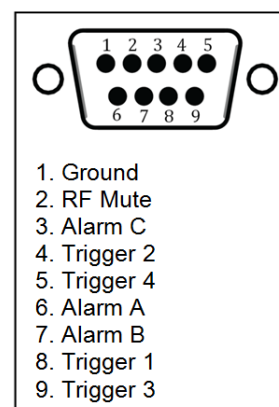

Figure 8.1: Alarms and Triggers Port

8.3.1 Enable

Enables/disables the trigger.

8.3.2 Action

Selects what the trigger will do when it is detected. Options are: *Frequency Up, Frequency Down, Power Up, Power Down, RF Mute, Switch to Int MPX, Switch to Ext MPX, Switch to Mono, Switch to Stereo, Reboot*. *Frequency Up, Frequency Down, Power Up, Power Down* and *Reboot* will perform the action on falling edges of the signal at the trigger pin. *RF Mute* acts based on voltage levels. *RF Mute* will be engaged for as long as the trigger signal is pulled low and unmute when the signal is high.

Note that the RFMute pin (Pin 2) mutes the unit unconditionally. (Triggers set to RFMute will not be able to unmute the unit if this pin is connected to ground).

8.3.3 Send e-mail

Selects if an e-mail will be sent when the trigger is fired. Make sure that the unit is connected to the network and that E-mails have been set up correctly **System** ⇒ **E-Mail** to use this feature.

8.3.4 (ON) Message

Sets the message that will be sent when the Trigger changes to ON. This parameter accepts text up to 300 characters.

Sample e-mail:

"Trigger 1 transitioned to ON.

Equipment: TX-V2, Serial Number #8790

Location:

Local IP Address: 192.168.5.31

If you require off-air emergency technical support, please contact the BW Broadcast 24/7 support team:

International Phone: +44 208 2530295

US Toll Free: 1-888-233-1663

Email: support@bwbroadcast.com

Please note that this is an automatic email alert generated by a BW Broadcast TX-V2. To prevent further emails please clear the cause of the alarm or turn off alarm emails on the TX-V2's control system."

8.4 Alarms

Alarms on the V2 Transmitter are used to indicate that a failure condition is met. They can be set to trigger on Modulation level, Forward power, Reverse power and PLL lock fail. Upon triggering they will toggle the relevant pin on the rear alarms and trigger connector. They will also write a notification to the RS232, write to the system log and send an e-mail if required. Alarm pins can be configured as open-collector Outputs (when working as alarms) or as Analogue outputs (for reporting system parameters as analogue voltages). When used as alarms (open-collector outputs), 10 kOhm external pull-up resistors to 12 V should be placed on each pin to be able observe voltage changes in the alarm pins.

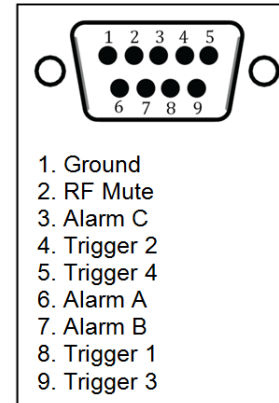

Figure 8.2: Alarms and Triggers Port

8.4.1 Type

Alarms can be configured as either alarms (open collector pins that will show '0' volts or open collector depending on the result of the condition tested); or as analogue outputs, which will report a parameter as an analogue voltage. The parameter **Type** allows this selection by providing the options *Alarm* and *Analogue Out*.

Alarms pins as Alarms

A Type

When the alarm **Type** is set to be *Alarm*, the system will look at the specified failure condition in the **Source** parameter and trigger the alarm if the condition has been present for longer than the specified **On Delay** time or release the alarm if the condition has not been present for longer than the specified **Off Delay** time.

B Source

Selects the failure condition that alarm will watch for. Options are: *Mod Level <*, *Mod Level >*, *Fwd Power <*, *Fwd Power >*, *Rev Power <*, *Rev Power >* and *PLL Lock Fail*.

- *Mod Level* observes conditions in the modulation (or deviation) level of the transmitted signal.

- *Fwd power* observes conditions in the Forward power

- *Rev power* observes conditions in the Reverse power

- *PLL Lock Fail* observes if the PLL lock has failed and the system cannot tune to the required frequency.

C **Threshold**

Selects the threshold value that will be used to detect the error condition. This doesn't apply to the PLL Lock Fail alarm.

D **Pin Polarity**

Selects whether the alarm output pin is active high or active low. When +ve is selected, the output will act as a 430 Ohm resistor to ground when the alarm is active and as a 100 KOhm resistor to ground when the alarm is not active and vice-versa if -ve is selected.

E **On Delay**

Selects how long the failure condition must be present for before the alarm is fired. This can be set from 2 seconds to 600 seconds.

F **Off Delay**

Selects how long the failure condition must have stopped for before the alarm is released. This can be set from 2 seconds to 600 seconds.

G **Send e-mail**

Selects if an e-mail will be sent when the alarm state changes. Ensure that the unit is connected to the network and that E-mails have been set up correctly **System** ⇒ **E-Mail** to use this feature.

Examples of alarm uses and set-up

Example 1: We would like the system to fire alarm A with normal polarity when the forward power has dropped below 40.5 watts for longer than 20 seconds. We would like the alarm to be release if the power rises above 40.5 watts for longer than 10 seconds.

Setup:

1. Navigate to **Alarms** ⇒ **Alarm A**
2. Select **Type** = *Alarm*
3. Select **Source** = *Fwd Power* <
4. Set **Fwd Power Threshold** to *40.5W*
5. Set **Pin Polarity** to +ve
6. Set **On Delay** to *20s*
7. Set **Off Delay** to *10s*
8. Set **Send e-mail** as required. Make sure emails are set up correctly if the feature is enabled (consult the relevant section in this manual)

Example 2: We would like the system to fire alarm B with inverted polarity when the modulation level has dropped below 30 kHz for longer than 15 seconds and release alarm B when the modulation level rises above that level for 5 seconds. This is a way of detecting that silence being transmitted.

Setup:

1. Navigate to **Alarms** ⇒ **Alarm B**
2. Select **Type** = *Alarm*
3. Select **Source** = *Mod Level <*
4. Set **Modulation Threshold** to *30kHz*
5. Set **Pin Polarity** to *-ve*
6. Set **On Delay** to *15s*
7. Set **Off Delay** to *5s*
8. Set **Send e-mail** as required. Make sure emails are set up correctly if the feature is enabled (consult the relevant section in this manual)

Example 3: We would like the system to fire alarm C with normal polarity when the reverse power increases above 10.35 watts for longer than 20 seconds. We would like the alarm to be release if the reverse power decreases below 10.35 watts for longer than 10 seconds.

Setup:

1. Navigate to **Alarms** ⇒ **Alarm C**
2. Select **Type** = *Alarm*
3. Select **Source** = *Rev Power >*
4. Set **Fwd Power Threshold** to *10.35W*
5. Set **Pin Polarity** to *+ve*
6. Set **On Delay** to *20s*
7. Set **Off Delay** to *10s*
8. Set **Send e-mail** as required. Make sure emails are set up correctly if the feature is enabled (consult the relevant section in this manual)

Alarms pins as Analogue Outputs

When the alarm **Type** is set to be *Analog Out*, the alarm pin will report the status parameter selected in **Source** as an analogue voltage on the alarms pins. This setup is typically used to connect the unit to remote control equipment (also known as telemetry interfaces). The **Source** can be set to any of the following parameters: *Fwd Power, Rev Power, PA Volts, Aux Volts, Peak Modulation, PA Temp, RF Mute*.

Use the following equation to translate voltage levels into parameter values:

$$CurrentValue = \frac{V_{Out} * 1.2 * NominalValue}{5} \quad (8.1)$$

Where:

V_{Out} is the voltage on the pin in Volts.

NominalValue is defined in the following table:

Parameter	NominalValue
FWD Power	For TX50 = 50Watts For TX300 = 300 Watts ...
REV Power	Same as FWD Power
PA Volts	For TX5 = 15 Volts For TX25 and TX50 = 24 Volts For TX300 or greater = 48Volts
Aux Volts	15 Volts
Peak Mod	100 kHz
PA Temp	100°C
*RF Mute	* This parameter does not use the above equation. Its representation is: If RF Mute = On, V_{Out} = 5 Volts If RF Mute = Off, V_{Out} = 0 Volts

For example, if the measured Voltage level is 4.166 Volts on a TX50 reporting Forward Power, the actual current value will be:

$$Power (watts) = (4.166 * 1.2 * 50) / 5 = 49.992 \text{ Watts (Approx. 50 Watts)}$$

8.5 System

8.5.1 Date

System Date. This is backed up by an internal battery.

8.5.2 Time

System Time. This is backed up by an internal battery.

8.5.3 Uptime

Reports how long the unit has been powered on for. This parameter accepts up to 20 characters of text.

8.5.4 Location

Stores the Physical location of the device (e.g. 'TX Site 3, Rack 5') It accepts up to 64 characters of text.

8.5.5 Contact

The name of the person who manages this device. This parameter accepts text of up to 64 characters.

8.5.6 Screen Saver

This allows the time-out before the screensaver starts. It can be adjusted between 15 seconds and 30 minutes.

8.5.7 Screen Lock

Enables/disables the screen lock code. If enabled, the system will request a 4 digit lock code to exit the screensaver.

8.5.8 Screen Lock Code

Sets the 4 digit screen lock code.

8.5.9 Users

Username

This is the username for the remote login (web remote interface). It accepts text of up to 15 characters.

Password

This is the password for the remote login. It accepts text of up to 15 characters

8.5.10 Ethernet

The V2 Transmitters have a built in web server which can monitor and control all transmitter parameters remotely without the need to install any software. The unit can use either static or dynamic IP addressing. All Ethernet parameters are set in this folder.

Ethernet Parameters:

DHCP

Sets whether the Ethernet is configured manually or by DHCP.

Parameters when DHCP is on:

- A **DHCP IP** This read only parameter shows the IP given by the DHCP to the unit.
- B **DHCP SM** This read only parameter shows the DHCP subnet mask.
- C **DHCP GW** This read only parameter shows the DHCP gateway
- D **DHCP DNS 1** This read only parameter shows the DHCP Primary DNS server.
- E **DHCP DNS 2** This read only parameter shows the DHCP Secondary server.
- F **MAC** This read only parameter shows the Ethernet MAC address.

Parameters when DHCP is off:

- A **Static IP** Sets the manual IP address. Accepts an IPv4 address in the form aaa.bbb.ccc.ddd
- B **Static SM** Sets the manual subnet mask. Accepts an IPV4 address in the form aaa.bbb.ccc.ddd
- C **Static GW** Sets the manual gateway. Accepts an IPV4 address in the form aaa.bbb.ccc.ddd
- D **Static DNS1** Sets the manual Primary DNS server. Accepts an IPv4 address in the form aaa.bbb.ccc.ddd
- E **Static DNS2** Sets the manual Secondary DNS server. Accepts an IPv4 address in the form aaa.bbb.ccc.ddd
- F **MAC** This read only parameter shows the Ethernet MAC address.

8.5.11 E-Mail

V2 Transmitters allow the sending of emails to provide notification of an alarm or external trigger being activated. The transmitter can either send emails via a user defined SMTP server or an SMTP server hosted by BW Broadcast. Note that SSL authentication is not supported.

Test

- A **Test** This will send a test-email.
- B **Recipient** Sets who the test email will be sent to. Multiple addresses must be separated by commas. This parameter accepts up to 99 characters of text.

Send via

This parameter sets the method used for sending e-mails. Options are *SMTP* or *BW Broadcast*. Please note that SSL authentication is not supported by the unit. An easier option to set up is to send the email via the *BW Broadcast* email relay service. In this case, the unit must be connected to the internet.

Parameters when **Send via** is set to *SMTP*:

- A **From** Sets the email address of the sender. The unit will send e-mails through this address. This parameter accepts up to 64 characters of text.
- B **Recipient(s)** Sets the recipients of the emails. Multiple addresses must be separated by commas. This parameter accepts up to 99 characters of text.
- C **Host** Sets the IP address of the SMTP server. This parameter accepts up to 64 characters of text.
- D **Port** Sets the port number of the SMTP server. This parameter accepts values from 1 to 1024.
- E **Username** Sets the username for SMTP authentication. This must be left blank if no authentication is required. This parameter accepts up to 64 characters of text.
- F **Password** Sets the password for SMTP authentication. This must be left blank if no authentication is required. This parameter accepts up to 64 characters of text.
- G **Max emails a day** Sets the maximum number of emails allowed to be sent by the unit in a single day. This is intended to stop spamming coming from intermittent fault conditions. This parameter accepts values from 1 to 1000.
- H **Emails sent today** Reports the number of emails sent today. This parameter accepts values from 0 to 1000.

Parameters when **Send via** is set to *BW Broadcast*:

- A **From** Sets the email address of the sender. The unit will send e-mails through this address. This parameter accepts up to 64 characters of text.
- B **Recipient(s)** Sets the recipients of the emails. Multiple addresses must be separated by commas. This parameter accepts up to 99 characters of text.
- C **Max emails a day** Sets the maximum number of emails allowed to be sent by the unit in a single day. This is intended to stop spamming coming from intermittent fault conditions. This parameter accepts values from 1 to 1000.
- D **Emails sent today** Reports the number of emails sent today. This parameter accepts values from 0 to 100000.

8.5.12 HTTP

V2 Transmitters provide a graphical web based interface for ease of use and control. This can be accessed by navigating to the IP address of the unit in any standard web browser. After entering the login details for the unit, the user can then read and write all parameters and also perform firmware upgrades. All parameters are saved and updated dynamically as they are changed in the remote.

Enable

Enables/disables the web server.

Port

Sets the webserver TCP port. Disable HTTP to change. This parameter accepts values from 1 to 1024.

Remote Control Indication

Displays a message on the screen when the unit is being controlled remotely through the web remote.

8.5.13 Telnet

For text based access via a local network or the internet, Telnet can be used to connect to the unit.

Enable

Enables/disables the telnet server.

Port

Sets the telnet TCP port. Telnet must be set to *Disabled* to change. This parameter accepts values from 1 to 1024.

8.5.14 RS232**Enable**

Enables/disables the RS232 remote.

Baud Rate

Sets the RS232 baud rate.

8.5.15 Log

V2 Transmitters have three methods of logging, regardless of the log location, the format is the same. V2 Transmitters will output a list of important parameters, all meter settings and alarm and trigger statuses 2 minutes after a parameter change and then at hourly intervals. These can be either received via RS232, UDP or saved to a file on the device. Each method can be enabled or disabled.

RS232

Enables/disables logging to RS232.

File

Enables/disables logging to file.

UDP

- A **Enable** Enables/disables logging messages to a remote UDP logging/syslog server.
- B **IP** Sets the IP address where the log messages should be sent via UDP. This parameter accepts IPv4 addresses in the form aaa.bbb.ccc.ddd.
- C **Port** Sets the port where the log messages should be sent via UDP. Disable UDP to change. This parameter accepts values from 1 to 10000.

8.5.16 Diagnostics

This set of parameters report the state of various parts of the system upon boot (OK or fail). If an error condition is observed, the unit should be re-booted and these parameters should be examined. This information will be useful when contacting support.

DSPX Comm

This read only parameter reports communication failure with DSPX chip (OK/FAIL). Restart the unit to refresh this value in case of failure.

Exciter Comm

This read only parameter reports communication failure with AIO exciter chip (OK/FAIL). Restart the unit to refresh this value in case of failure.

Alarms DAC Comm

This read only parameter reports communication failure with Alarms DAC chip (OK/FAIL). Restart the unit to refresh this value in case of failure.

Power DAC Comm

This read only parameter reports communication failure with Power DAC chip (OK/FAIL). Restart the unit to refresh this value in case of failure.

8.5.17 About

Product ID

This read only parameter displays the product ID.

Product Version

This read only parameter displays the product version.

Serial Number

This read only parameter displays the serial number.

Hardware Version

This read only parameter displays the HW version.

Software Version

This read only parameter displays the SW version.

Control Version

This read only parameter displays the control board version.

AIO FW Version

This read only parameter displays the AIO(All in One) PLL+ firmware version.

8.5.18 Reboot

Reboots the unit. When the reboot is performed from the FP, a confirmation window will pop up asking to confirm the choice.

8.5.19 Factory Reset

Performs a factory reset, setting all the parameters to its default value. All user changes will be lost except network settings.

Part IV

Troubleshooting

V2 FM Transmitter Troubleshooting Guide

There is no or low RF output power

- Please ensure that you are using the correct mains voltage as specified in the transmitter's technical manual.
- On the menu, check that the unit is not set to RF mute or that the alarm ports at the back are not set to RF mute.
- If the unit has a slide-in power supply, please check that the power supply is pushed in correctly at the back of the unit.
- Check that the set power on the menu is the desired RF power. (BW Broadcast transmitters are set to minimum output power when they leave the factory. This can be adjusted on the front panel via **RF settings** ⇒ **Power**. You may want to increase this parameter to the desired power.
- Check that the **Power Scheduler** feature is disabled (if not required). Or set-up correctly if required. Check that the System time is correct. All these settings are contained in the folder: **RF Settings** ⇒ **Power Scheduler**

VSWR fault light is on

- The front panel VSWR fault LED illuminates when there is high reverse RF power from the antenna. This is usually caused by factors external to the transmitter. In this case, please check the antenna, cable and connectors, as well as the antenna itself.

I am not able to change any settings on the unit (Passcode)

- This usually means that the front panel screen has been locked with a 4 digit passcode. The original 4 digit code has to be entered before any settings can be changed. Once the correct code is inserted, press the middle button on the right hand side to confirm the passcode.

I have no modulation

- Please check that the correct input source has been selected on the front panel controller **Audio Settings** ⇒ **MPX Source**. If you are using the digital or analog inputs (XLR connectors), this option must be set to *Internal*. If you are using the external MPX BNC input, this option must be set to *External*.

Modulation level is too low

- Most professional signal sources will be able to drive BW Broadcast transmitters to full deviation. Some battery-powered or weaker sources, such as PC sound cards, may not be able to provide enough drive to achieve full modulation in the transmitter. If using the XLR inputs and the internal audio processor then we advise that you check the meters screen in the Front Panel (Please press the bottom button on the right until meters screen appears). Assuming that the transmitter preset is not set to *Bypass*, then you should be able to observe movement on the meters labeled "LIM" and "AGC". If you they do not move, then you should increase the level in your audio source so that they do.

If you are not able to increase your audio level from your external audio source you can increase it by adjusting the level pot located on the left hand side of the 2 BNCs on the rear panel.

I am using the MPX input and have strange sound issues

- Ensure that **Audio Settings** ⇒ **MPX Source** is set to *External*.
- Leaving it switched to *Internal* will feed the internal stereo generator audio into the exciter. This will result in distortion and interference with the signal you are feeding from your external composite source connected to the MPX input of the transmitter.

Transmitter occasionally changes RF power

- Please check that the Power Scheduler feature is not enabled (**RF Settings** ⇒ **Power Scheduler**). If this feature is required, ensure it is correctly set-up and the time in the system is correct. Please refer to **Operation Guide** ⇒ **RF Settings** ⇒ **Power Scheduler** on this manual to properly configure this feature.

Temp fault light is on

- Please ensure that the fans are running and not obstructed and the transmitter is in a well ventilated area.

Other Issues

If your issue is not covered in this guide or you have tried the above and still having trouble, you can contact our 24 Hour Support Team:

International Phone: +44 208 253 0295

US Toll Free: +1-888-233-1663

Email: support@bwbroadcast.com

Part V

Technical Specifications

Technical Specifications

10.1 Common Specifications

10.1.1 RF

Harmonics	better than -75 dBc
Spurious	<-90dBc
Frequency range	87.5 - 108 MHz
Frequency steps	50 kHz
Frequency selection	User interface with display or web remote control
Frequency control type	Dual speed phase locked loop
Frequency stability	<+/- 500 Hz (fine adjustment available)
Modulation	Direct frequency modulation
Synchronous AM Noise	>70dB
Asynchronous AM Noise	>70dB

10.1.2 Audio and MPX I/O

MPX input connector	BNC
MPX input level	MPX input level -10 dB to +10 dB (adjustable)
MPX input response	MPX input response +/- 0.02 dB, 5 Hz to 100 kHz
Audio input connectors	XLR balanced
Analog Input impedance	10 kOhm
AES/EBU Sampling Rates	32kHz, 44.1kHz, 48kHz, 88.2kHz and 96kHz

10.1.3 Stereo

Subcarrier generation	Microprocessor generated 8x over-sampled
Pilot	19 kHz +/- 1 Hz (adjustable)
Pilot generation	Microprocessor generated 16x over-sampled
Output level	+6dBu (BNC)
15 kHz filtering	>= 80dB at 19kHz (DSP based)
Overshoot filter clipping	DSP based
Spurious	
>80 kHz	> -60dBr
>160 kHz	> -80dBr
Stereo separation	>50dB (20Hz - 15kHz)

10.1.4 Limiter

Audio input levels	-10dB to +24dB for level control, DSP auto levelling
Input CMRR	> 60dB
Audio distortion	<0.05% at limiting 1 KHz (bypass preset)
Frequency response	20 Hz to 20 kHz +/- 0.2dB (pre-emphasis off)
Processing range	Processing control range 40dB
Pre-emphasis	50 μ s, 75 μ s and 0 μ s (off)
Processing type	Multiband DSP Processor. DSPXmini FMSE
Process modes	Multiple presets

10.1.5 Other

User Interface	3 buttons, rotary encoder and 256x64 graphics display
External control/monitor	I/O Alarms D9-type Male; RS232 D9-Type Female, Telnet and Web remote RJ45 Ethernet

10.1.6 Temperature Protection

The temperature protection circuitry will protect the unit against over-temperature conditions by reducing the output power. The reduction will start at 71 °C. At 81 °C, the power will be reduced to 50% and at 85 °C to around 6%.

10.1.7 VSWR Protection

The VSWR protection circuitry will protect the unit against high VSWR conditions by reducing the output power. This protection will reduce the output power to 50% when the reverse power is 10% of the forward power.

10.2 Model-Specific Specifications

10.2.1 TX5 V2

Size	485mm x 350mm x 45mm
Weight	2kg
Voltage input	100 - 265 VAC
Power connector	IEC
Switched mode approvals	UL / TUV / CE
Power Consumption	30W average @ 5W RF
Power	0.05W - 5.05W Continuous
Power Supply	Internal
Connector	N-type 50 Ohm
Approvals:	CE/RTTE –applicable harmonised standards FCC Part 73 verified

10.2.2 TX30 V2

Size	485mm x 350mm x 45mm
Weight	6.8kg
Voltage input	100 - 265 VAC
Power connector	IEC
Switched mode approvals	UL / TUV / CE
Power Consumption	85W average @ 30W RF
Power	5.4W - 30.15W Continuous
Power Supply	Internal
Connector	N-type 50 Ohm
Approvals:	CE/RTTE –applicable harmonised standards FCC (FCC ID: TUO TX25-50)

10.2.3 TX50 V2

Size	485mm x 350mm x 45mm
Weight	6.8kg
Voltage input	100 - 265 VAC
Power connector	IEC
Switched mode approvals	UL / TUV / CE
Power Consumption	104W average @ 50W RF
Power	5.4W - 50.4W Continuous
Power Supply	Internal
Connector	N-type 50 Ohm
Approvals:	CE/RTTE –applicable harmonised standards FCC (FCC ID: TUO TX25-50)

10.2.4 TX300 V2

Size	485mm x 510mm x 90mm
Weight	6.8kg
Voltage input	100 - 265 VAC
Power connector	IEC C20 (C19 cable)
Switched mode approvals	UL / TUV / CE
Power Consumption	465W average @ 300W RF
Power	30.8W - 310.8W Continuous
Power Supply	Internal
Connector	N-type 50 Ohm
Approvals:	CE/RTTE –applicable harmonised standards FCC (FCC ID: 2ABPH-TX300V2) IC (11730A-TX300V2)

10.2.5 TX600 V2

Size	485mm x 510mm x 90mm
Weight	9.3kg
Voltage input	100 - 265 VAC
Power connector	IEC C20 (C19 cable)
Switched mode approvals	UL / TUV / CE
Power Consumption	920W average @ 600W RF
Power	60.5W - 610.5W Continuous
Power Supply	Slide-in type
Connector	N-type 50 Ohm
Approvals:	CE/RTTE –applicable harmonised standards FCC (FCC ID: TUO TX600)

10.2.6 TX1000 V2

Size	490mm x 510mm x 95mm
Weight	13.4kg
Voltage input	220 - 240 VAC
Power connector	IEC C20 (C19 cable)
Switched mode approvals	UL / TUV / CE
Power Consumption	1580W average @ 1000W RF
Power	152W - 1102W Continuous
Power Supply	Slide-in type
Connector	7/16 Connector 50 Ohm
Approvals:	CE/RTTE –applicable harmonised standards FCC Part 73 verified

10.2.7 TX1500 V2

Size	490mm x 510mm x 95mm
Weight	13.4kg
Voltage input	220 - 240 VAC
Power connector	IEC C20 (C19 cable)
Switched mode approvals	UL / TUV / CE
Power Consumption	2344W average @ 1500W RF
Power	162W - 1512W Continuous
Power Supply	Slide-in type
Connector	7/16 Connector 50 Ohm
Approvals:	CE/RTTE –applicable harmonised standards FCC Part 73 verified

10.2.8 TX2500 V2

Size	490mm x 510mm x 133mm
Weight	19.5kg
Voltage input	220 - 240 VAC
Power connector	IEC C20 (C19 cable)
Switched mode approvals	UL / TUV / CE
Power Consumption	3325W average @ 2500W RF
Power	520.5W - 2550W Continuous
Power Supply	2 x Slide-in
Connector	7/16 Connector 50 Ohm
Approvals:	CE/RTTE –applicable harmonised standards FCC Part 73 verified

THIS PAGE IS INTENTIONALLY LEFT BLANK